

A PERFECT ALLIANCE.

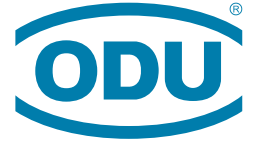

ODU AMC[®] EASY-CLEAN

Rugged miniature circular connector
with Easy-Clean function

EASY-CLEAN
BREAK-AWAY



ODU AMC[®] EASY-CLEAN

ODU AMC[®]

ODU AMC[®] HIGH-DENSITY

ODU THREADED CONNECTOR

ODU AMC®

FEATURES

- Low weight and compact design
- Easy handling
- Watertight
- Blind mateable
- Robust
- EMC shielding
- Robust mechanical and optical coding
- Resist all kinds of extremes like dust, temperature, humidity, corrosion, radiation and shock vibration

APPLICATIONS

- Communication systems (PTT, PRR)
 - Rugged computers and hand-helds
 - Power supply
 - Unmanned systems
 - Optical devices
 - Nightvision systems
 - Software defined radions
 - Defence and security
-



All shown connectors are according to IEC 61984:2008 (VDE 0627:2009); connectors without breaking capacity (COC).

ODU AMC® Easy-Clean is UL-listed under file E110586.

Issue: 2020-03

Printed on certified recycled paper.



TABLE OF CONTENTS

Clickable page
numbers

THE ODU CORPORATE GROUP	<u>4</u>
PRODUCT INFORMATION	<u>11</u>
ODU AMC® introduction	<u>12</u>
ODU AMC® Easy-Clean product features	<u>12</u>
ODU AMC® Easy-Clean product range and solutions	<u>13</u>
Related products	<u>13</u>
ODU AMC® Easy-Clean locking mechanism	<u>14</u>
CONFIGURATION GUIDELINE	<u>17</u>
ODU AMC® EASY-CLEAN	<u>23</u>
Summary	<u>24</u>
Break-Away plug	<u>25</u>
Panel plug rear mount	<u>26</u>
In-line receptacle	<u>27</u>
Receptacles	<u>28</u>
Coding possibilities	<u>30</u>
Housing material	<u>30</u>
Contact configurations and PCB layouts	<u>32</u>
Protection caps	<u>38</u>
TECHNICAL INFORMATION	<u>41</u>
Technical data	<u>42</u>
Protection	<u>44</u>
International protection classes	<u>45</u>
Spring loaded contact	<u>46</u>
Current load contact	<u>47</u>
Operating voltage	<u>48</u>
Conversion / AWG	<u>50</u>
Technical terms	<u>51</u>

A PERFECT ALLIANCE

Creating connections, building alliances, collaborating into the future: Whether two technical components come together to form a unit or people come together to strive for great results – the key is to aspire to achieve superb results. This goal drives our work. **Perfect connections that inspire and deliver on the promises.**



ODU GROUP OVERVIEW

- Almost 80 years of experience in connector technology
- Over 2,300 employees worldwide
- Sales subsidiaries in China, Denmark, France, Germany, Hong Kong, Italy, Japan, Korea, Romania, Sweden, UK and the US as well as 5 production and logistics sites
- All technologies under one roof: Design and development, machine tool and special machine construction, injection, stamping, turning, surface technology, assembly and cable assembly

As of February 2020

CERTIFICATES & APPROVALS

- ISO 9001
- IATF 16949
- ISO 13485
- ISO 14001
- ISO 50001
- Wide range of UL, CSA, VG and VDE approvals
- UL Wiring Harnesses certified

For a complete list of our certifications and approvals, please visit our website.

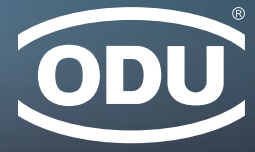

WORLDWIDE CUSTOMER PROXIMITY

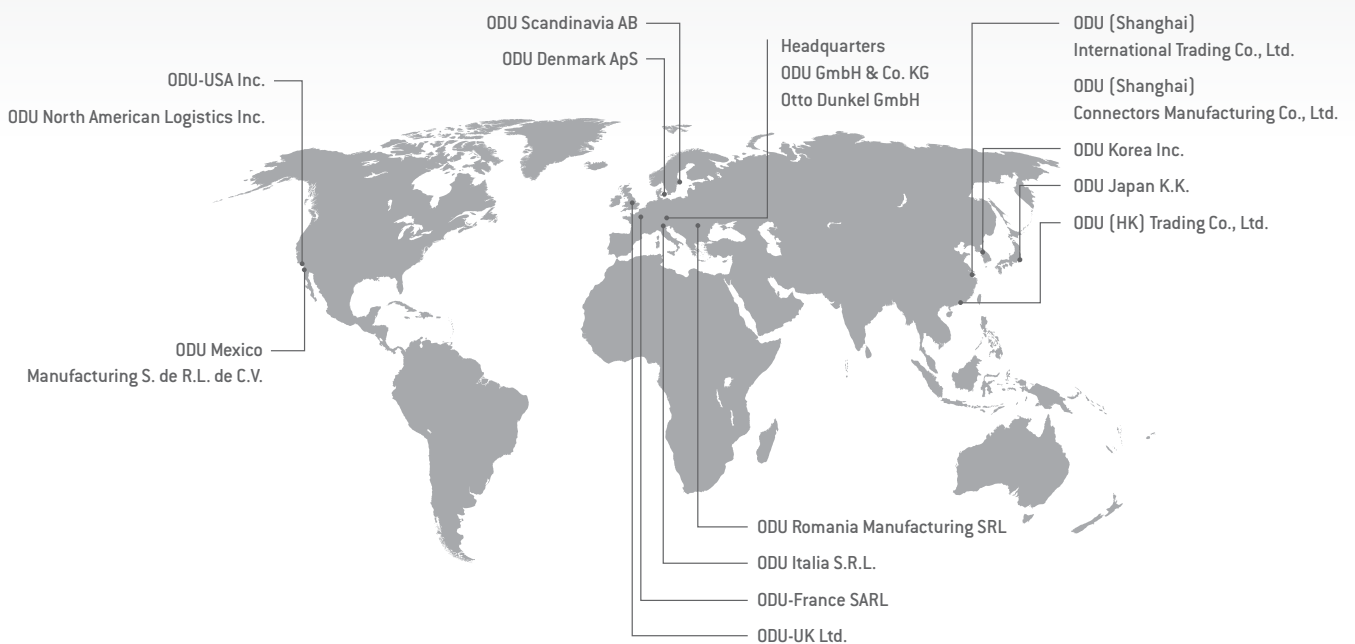

CONNECTIONS THAT LIVE UP TO ANY REQUIREMENT



ELECTRICAL CONTACTS

- Versatile contact technologies
- Outstanding reliability and durability
- Current-carrying capacity of up to 2,400 A
- Rugged and universal contact systems
- Stamping technology for customer-specific high volume solutions
- Very high vibration resistance
- Low, stable contact resistance

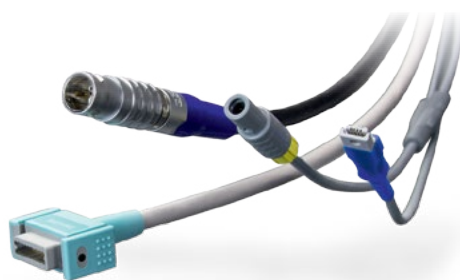

CABLE ASSEMBLY

- Complete system solutions from one source based on years of expertise
- State-of-the-art production facilities with 100 % end testing
- Cable assembly available for ODU products
- Overmolding in silicone, hot-melt and high-pressure procedures
- Customer-specific labeling and cable printing
- Wide range of standard cables and accessories available
- Prototype, small series and high volume production
- Rapid prototyping



CIRCULAR CONNECTORS

- Circular connector series in robust metal or plastic housing
- Contacts for soldering, crimping and PCB termination
- Different locking systems available: Push-Pull and Screw-Locking options or Break-Away function for quick release
- 2 up to 55 contacts
- Protection classes IP50 to IP69
- Autoclavable for medical applications
- Hybrid inserts for combined transmission
- Including cable assembly – system solution from one source



APPLICATION AND CUSTOMER-SPECIFIC SOLUTIONS

- Contacts, connectors and cable assemblies for the highest technical requirements as well as special applications
- First-class implementation expertise
- High level of vertical manufacturing – all competences and key technologies under one roof
- Expert advice based on mutual partnership
- Short development and production paths



MODULAR CONNECTORS

- Application-specific hybrid interface
- For manual mating and automatic docking
- Flexible modular construction and highest packing density
- For the transmission of signals, power, high current, high voltage, HF signals (coax), media, high-speed data or fiber optics
- Variety of locking options available
- Mating cycles scalable as required from 10,000 to over 100,000 (1 million)
- Including cable assembly – system solution from one source

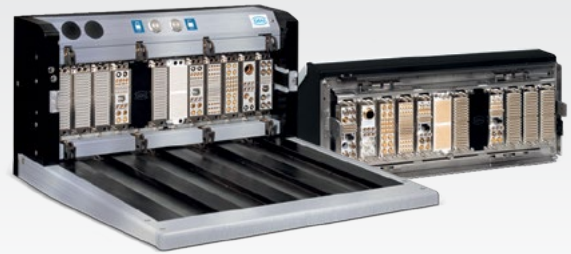

MASS INTERCONNECT SOLUTIONS

- For testing printed circuit boards (PCBs) and electronically assembled units
- Innovative engagement option: electromechanical version
- 8 tensioning points stop the frame distorting
- Very high flexibility thanks to ODU-MAC® modules
- Adapter frame (ITA) with tolerance compensation
- Including cable assembly – system solution from one source



HEAVY DUTY CONNECTORS

- Extremely durable even under extreme / harsh environments
- High vibration resistance
- Up to 400 A (higher currents upon request)



PRINTED CIRCUIT BOARD CONNECTORS

- Maximum flexibility in application designs
- High resilience and outstanding quality
- Including cable assembly – system solution from one source

OUR KNOW-HOW FOR YOUR SUCCESS

Customers rely on ODU technology wherever first-class, high-performance connector solutions are required.

All our skills go into our products to ensure your success.

In addition to the top quality, reliable stability and maximum flexibility our products also stand for **dynamics, reliability, safety, precision, efficiency and sustainability.**

HIGH PERFORMANCE CONNECTOR TECHNOLOGY FOR DEMANDING KEY MARKETS

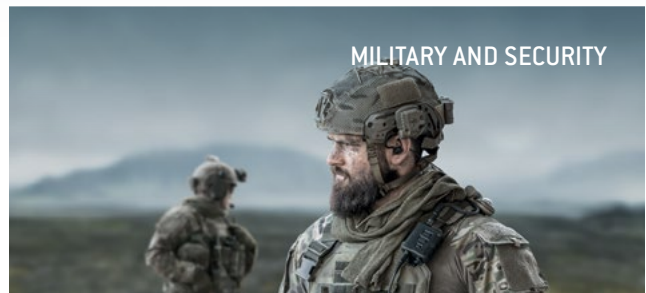

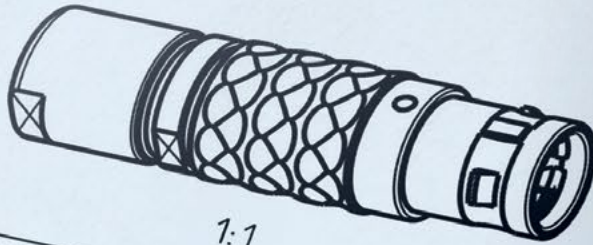

S12L_C-P03MSNO-9900	> 9.0 - 9.9 mm
S12L_C-P03MSNO-9200	> 8.0 - 9.2 mm
S12L_C-P03MSNO-8200	> 7.0 - 8.2 mm
S12L_C-P03MSNO-7200	> 6.0 - 7.2 mm
S12L_C-P03MSNO-6200	> 5.0 - 6.2 mm
S12L_C-P03MSNO-5200	> 4.0 - 5.2 mm

MORE THAN A CONNECTION

Contacts, connectors and cable assembly system solutions meeting the most demanding technical market requirements – ODU’s connector solutions and value-added services are characterized by their exclusive focus on meeting the customer’s needs.

- Precise implementation of application-specific requirements regarding design, functionality, cost and exclusivity
- Modified connector solutions derived from standard products
- One-to-one local expertise and fair, friendly consulting
- Short development and production paths

DEVELOPMENT OF CUSTOM SOLUTIONS

Demands that can’t be pigeon-holed call for creative specialists who think outside the box. ODU offers the type of expertise that focuses solely on the specific requirements of our customers.

For every development order we get, we not only perform a thorough check to make sure it’s feasible, we intensively incorporate our customers in the ongoing design process.

This guarantees impressive, custom-fit final end products.

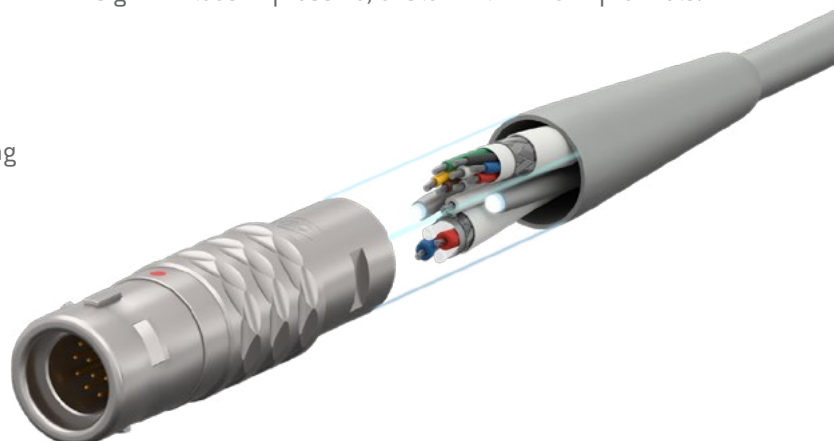



ODU AMC[®] EASY-CLEAN



PRODUCT INFORMATION

ODU AMC® introduction	12
ODU AMC® Easy-Clean product features	12
ODU AMC® Easy-Clean product range and solutions	13
Related products	13
ODU AMC® Easy-Clean locking mechanism	14

ODU AMC[®] INTRODUCTION

A CONNECTOR THAT YOU CAN DEPEND ON

ODU AMC[®] is a rugged miniature connector solution for extreme environments. The connectors are waterproof when mated and unmated, offer robust mechanical coding with a visual indicator, and are EMI shielded.

The connectors have been designed and tested to survive many of the factors detrimental to the performance of connectors in harsh environments, including: sand and dust, extreme temperatures, humidity, corrosion, solar radiation, shock, vibration and torque.

Whether in extreme environments or under high mechanical stress, ODU connectors ensure reliable electrical communication, even in the most demanding conditions.

The ODU AMC[®] is available in a wide range of sizes and contact inserts. You can choose between four versions – Push-Pull, Break-Away, Easy-Clean and High-Density.



ODU AMC[®] EASY-CLEAN PRODUCT FEATURES

VARIOUS SIZES AND CONFIGURATIONS AVAILABLE

- 3 standard connector shell sizes
- Plug outer diameter 11.9 mm to 15.9 mm
- 4 to 19 contacts
- International protection class IP6K8 and IP6K9K

MATERIALS AND APPLICABILITY

The ODU AMC[®] connector series uses PEEK as the insulator material.

The housings are made of aluminum, and plated with ruthenium over nickel [see page 65 for more information].

Operating temperature range: -51 °C to +125 °C. This rugged and versatile connector series is ideal for defense & security applications as well as industrial electronics.

COMPLETE SYSTEM SOLUTION

Every connection has a unique cable requirement. Make no compromise when it comes to the quality of the complete interconnect system. ODU gives you the complete system solution from one source, without the need for an intermediary supplier. Services include:

- 100 % outgoing inspection
- EN ISO 14644-1:2015 clean room assembly available
- Factory-automated equipment and processes [cutting, stripping, etc.]
- Low- and high-pressure overmolding
- Ultrasonic welding
- EMI shielded enclosure assembly
- Custom labeling
- Various potting options for sealed systems
- Overmolded cable transitions [1-to-2, 1-to-3, etc.]

ODU AMC® EASY-CLEAN CONNECTORS

PRODUCT RANGE AND SOLUTIONS

	Coding	Size	No. of possible mechanical codings	Plug diameter in mm	Max. cable diameter in mm	Number of max. contacts	Solder	PCB	International protection class A ¹
	Pin and groove	0	4	11.9	5.5	7	•	•	up to IP6K9K
		1		13.9	6.5	16			
		1,5		15.9	8.0	19			

¹ International protection class in mated condition

RELATED PRODUCTS OF THE ODU CIRCULAR CONNECTOR SERIES



- High speed data technology
- Secure Push-Pull locking and Break-Away function
- Contacts for solder and PCB termination
- International protection class IP6K8K and IP6K9K
- Small and compact design
- High-contact density
- High-speed data transmission capable
- Break-Away function
- International protection class IP6K8
- With dual-locking option
- High reliability for harsh environments
- Screw locking with ratchet mechanism half turn to fully mate
- High vibration resistant
- International protection class IP6K8
- More mating cycles than most MIL spec. connectors
- Circular Push-Pull connector with metal housing
- Wide variety of contact configurations and combinations
- International protection class IP50 and IP68

ODU AMC[®] EASY-CLEAN LOCKING MECHANISM – THE PERFECT CONNECTION

ODU offers you high-quality connectors and comprehensive service for the complete assembly. From connectors to watertight potting, we provide the complete system as an one-stop-shop solution.

BREAK-AWAY FUNCTION

The Break-Away function allows connectors to be mated and unmated in fractions of a second. As a safety measure, features in the connector allow the plug and receptacle to separate when the connector is in axial tension.

During the mating process, locking tabs on the plug align with corresponding grooves in the receptacle, but the geometry of the locking tabs is such that the connectors will separate when the specific retention force of the mechanism is exceeded. As a result, disconnection of the system can be triggered by pulling on the plug connector, the receptacle connector or cables attached to either.

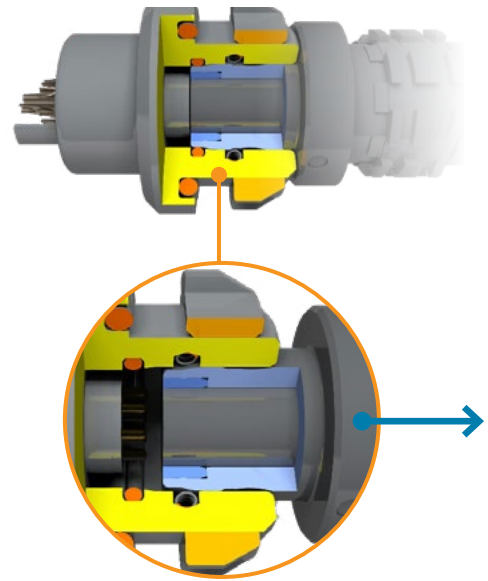

FOR YOUR NOTES

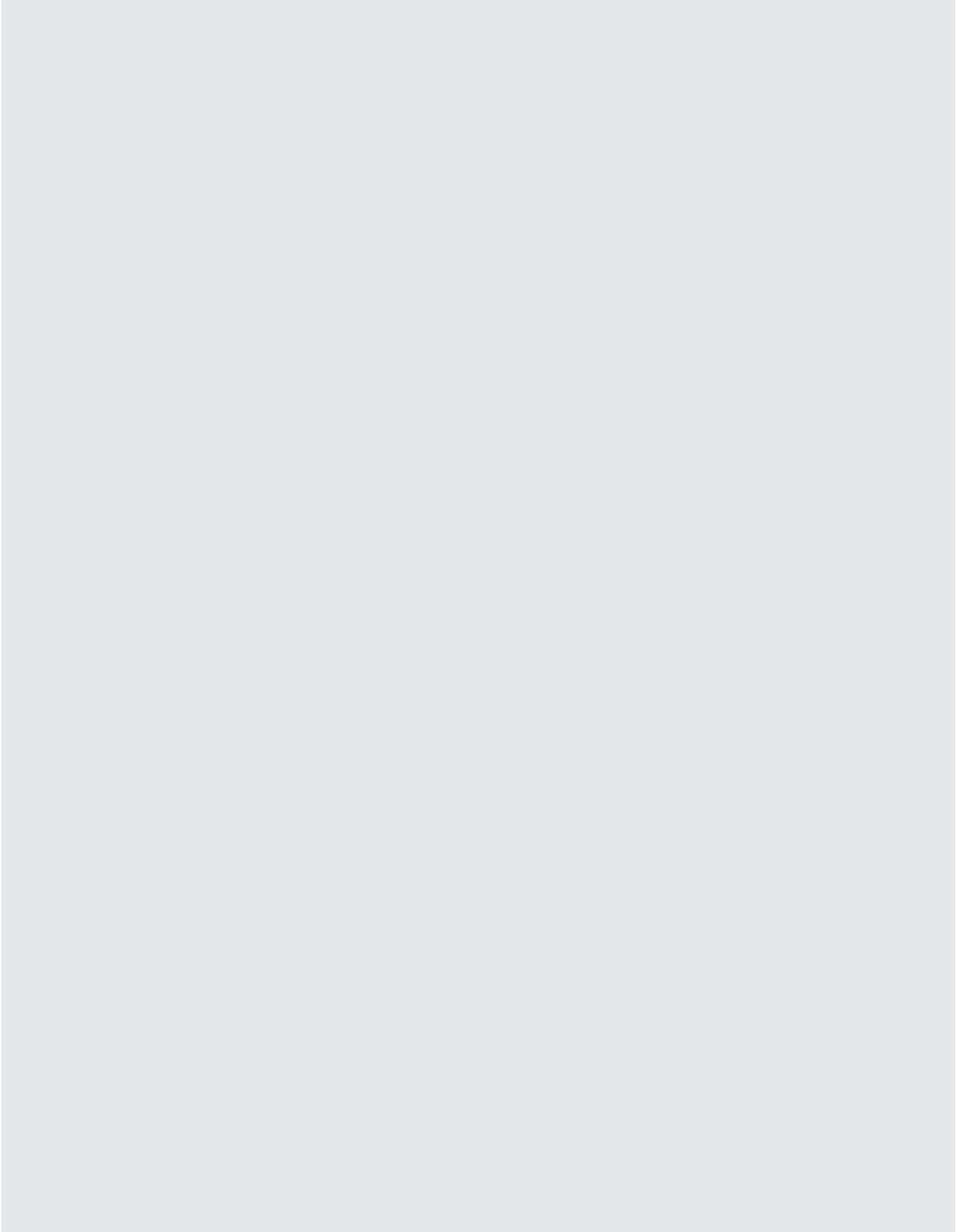



ODU AMC[®] EASY-CLEAN



CONFIGURATION GUIDELINE

Correct configuring – step by step

BIT BY BIT TO THE PERFECT CONNECTION

ODU offers you high-quality connectors and comprehensive service for the complete assembly. From connectors to watertight potting, we provide the complete system from a single source.



SAMPLE CONFIGURATION STEP BY STEP

The perfect product for you in just a few steps. These step-by-step instructions show you how to configure your own individual product with the ODU part number key based on a sample configuration.

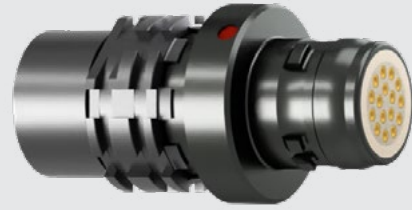

Break-Away Plug / size 1 / AMC® series YR / coding A / connector plug housing ruthenium over aluminium / insulator PEEK / 16 contacts / solder flat contact / contact diameter 0.6 / termination cross section AWG 26

STEP 1: SERIES (SEE POSITION 4)

1	2	3	4	5	6	7	8	9	10	11	12	13	14	15	16	17	18	19
			Y			-									-	R		0

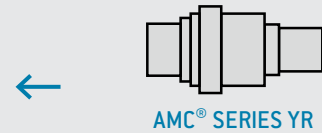

STEP 2: TYPE/STYLE (SEE POSITIONS 1, 2, 16, 17 AND 19)

PAGE 25 – 29

1	2	3	4	5	6	7	8	9	10	11	12	13	14	15	16	17	18	19	
A	1		Y			-									-	R	0	0	0

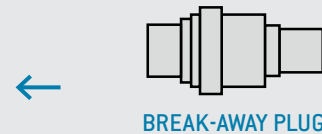

STEP 3: SIZE (SEE POSITION 3)

PAGE 32 – 37

1	2	3	4	5	6	7	8	9	10	11	12	13	14	15	16	17	18	19	
A	1	1	Y			-									-	R	0	0	0

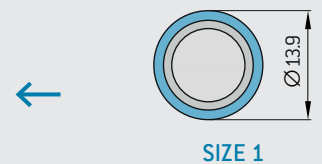

STEP 4: CODING (SEE POSITION 5)

PAGE 30

1	2	3	4	5	6	7	8	9	10	11	12	13	14	15	16	17	18	19	
A	1	1	Y	A		-									-	R	0	0	0

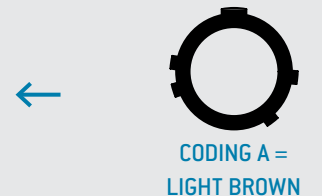

STEP 5: HOUSING MATERIAL (SEE POSITION 6)

PAGE 30

1	2	3	4	5	6	7	8	9	10	11	12	13	14	15	16	17	18	19	
A	1	1	Y	A	R	-									-	R	0	0	0



YOUR WAY TO AN INDIVIDUAL CONNECTION:

HOW TO CONFIGURE WITH THE PART NUMBER KEY

This shows you how ODU's part number key is composed. In the first part of the configuration, select the connector plug housing (such as style and size) of the connector. In the middle part of the part number key, you configure the contact insert and then the cable entry.

Type

A = Break-Away connector

G = Receptacle / panel mounted plug

K = In-line receptacle

Material insulator

(PEEK = standard)

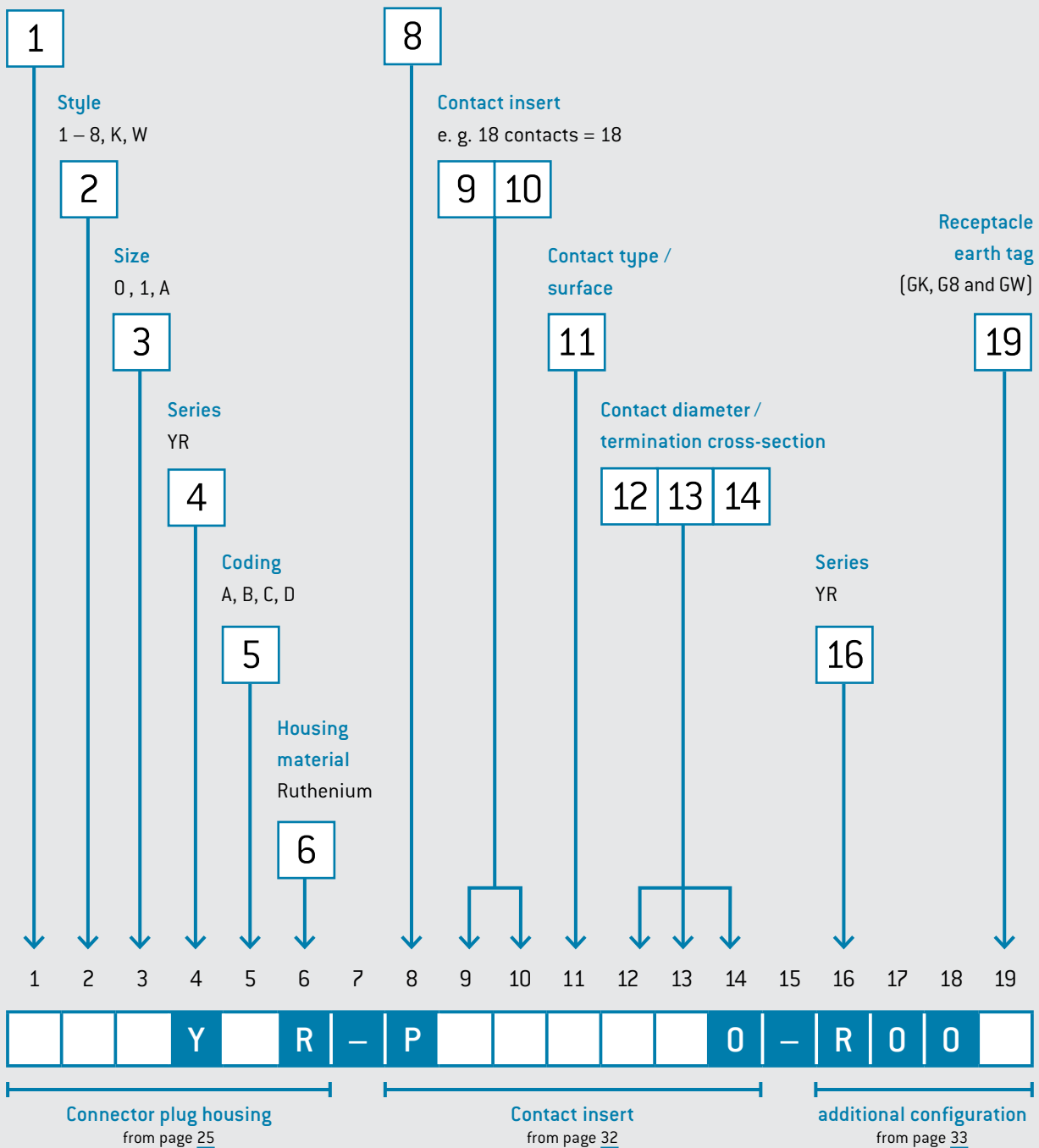

STEP 6: INSULATOR MATERIAL (SEE POSITION 8)

1	2	3	4	5	6	7	8	9	10	11	12	13	14	15	16	17	18	19
A	1	1	Y	A	R	-	P						0	-	R	0	0	0



STEP 7: CONTACT INSERT (SEE POSITIONS 9 AND 10)

PAGE 32 – 37

1	2	3	4	5	6	7	8	9	10	11	12	13	14	15	16	17	18	19	
A	1	1	Y	A	R	-	P	1	6					0	-	R	0	0	0



STEP 8: CONTACT TYPE / SURFACE (SEE POSITION 11)

1	2	3	4	5	6	7	8	9	10	11	12	13	14	15	16	17	18	19	
A	1	1	Y	A	R	-	P	1	6	W				0	-	R	0	0	0



STEP 9: CONTACT DIAMETER (SEE POSITION 12)

1	2	3	4	5	6	7	8	9	10	11	12	13	14	15	16	17	18	19	
A	1	1	Y	A	R	-	P	1	6	W	D			0	-	R	0	0	0

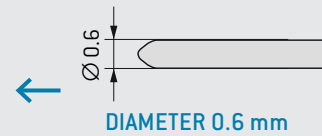

STEP 10: TERMINATION CROSS-SECTION (SEE POSITIONS 13)

1	2	3	4	5	6	7	8	9	10	11	12	13	14	15	16	17	18	19	
A	1	1	Y	A	R	-	P	1	6	W	D	D		0	-	R	0	0	0

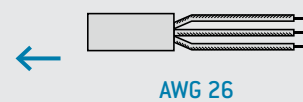



ODU AMC® EASY-CLEAN

[Table of contents](#)



ODU AMC[®] EASY-CLEAN

Summary	24
Break-Away plug	25
Panel plug rear mount	26
In-line receptacle	27
Receptacles	28
Coding possibilities	30
Housing material	30
Contact configurations and PCB layouts	32
Protection caps	38

SUMMARY ODU AMC® EASY-CLEAN

ODU AMC® Easy-Clean use pin and groove coding and additional to mechanical also optical color coding. These robust circular connectors can be configured in variety ways.

- Mechanical coding over pin and groove
- 4 to 19 contacts
- Up to 3 sizes
- Protection class IP6K8 and IP6K9K
- 5,000 mating cycles
- Spring loaded contacts for solder and print termination

IN-LINE RECEPTACLE

P. 27

K 1



BREAK-AWAY PLUG

P. 25

A 1



RECEPTACLES

P. 28

G K



PANEL PLUG REAR MOUNT

P. 26

G W



G 8



For assembly instructions please refer to our website: www.odu-connectors.com/downloads

BREAK-AWAY PLUG

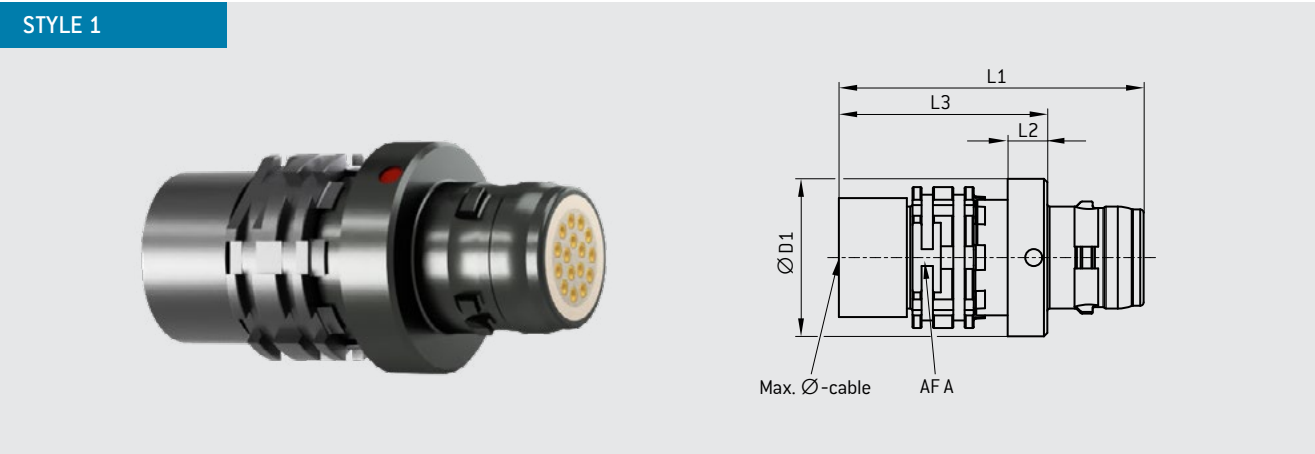

Size		L1 mm	L2 mm	L3 mm	D1 mm	AFA mm	Max Ø-cable ¹ mm
0	0	23.5	3.0	15.0	11.9	9	5.5
1	1	26.9	3.5	18.4	13.9	11	6.5
1.5	A	27.5	3.5	18.5	15.9	12	8.0

TECHNICAL DATA

- Technical data see page 42
- Contact configuration see page 32
- Cable assembly information see ODU instruction 010.645.001.000.004 (available at www.odu-connectors.com/downloads/assembly-instructions/)

¹ Based on cable with one braided shield

↓

1	2	3	4	5	6	7	8	9	10	11	12	13	14	15	16	17	18	19
A	1		Y		R	-	P						0	-	R	0	0	0

PANEL PLUG REAR MOUNT

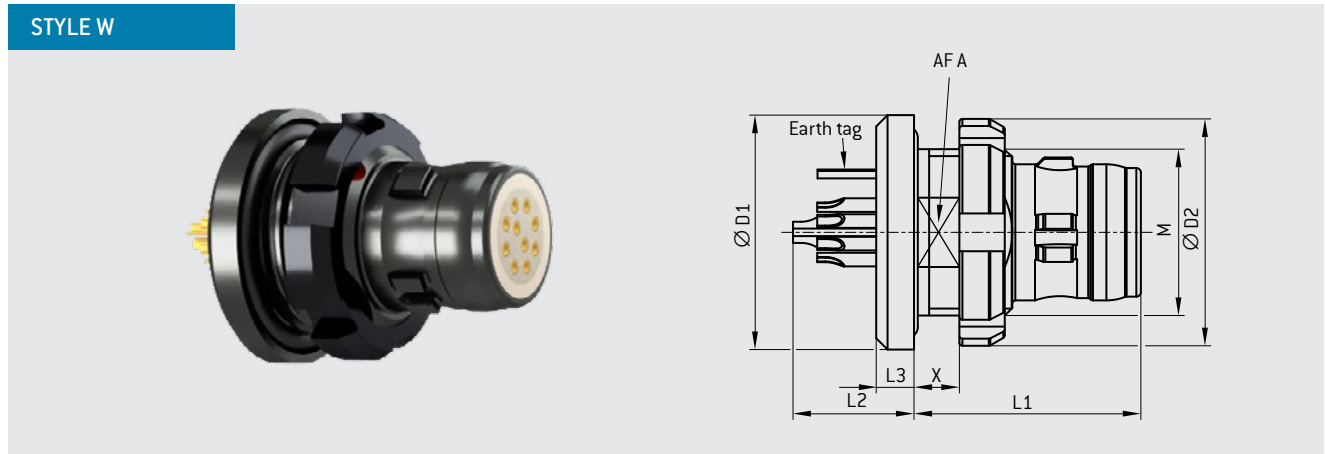

Size		L1 mm	L2 mm	L3 mm	X max mm	D1 mm	D2 mm	AF A mm	M mm	Panel cut out AF mm	Ø mm
0	0	15.0	6.4	2.5	3.0	13.2	12.8	9.2	10×0.5	9.3	10.1
1	1	15.0	8.0	2.5	3.5	15.5	15.0	10.0	11×0.75	10.1	11.1
1.5	A	16.5	9.7	4.0	3.5	17.5	17.9	13.0	14×0.75	13.1	14.1

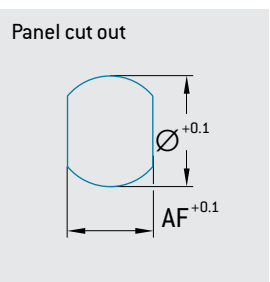

NUTDRIVER FOR SLOTTED NUT

Size	Number	Torque Nm
0	700.098.005.000.000	0.8
1	701.098.001.000.000	1.0
1.5 (A)	701.098.002.000.000	3.0

TECHNICAL DATA

- Technical data see page 42
- Contact configuration and PCB layout see page 32

↓

1 2 3 4 5 6 7 8 9 10 11 12 13 14 15 16 17 18 19

G | W | Y | R | - | P | | | | | O | - | R | O | O | L

IN-LINE RECEPTACLE

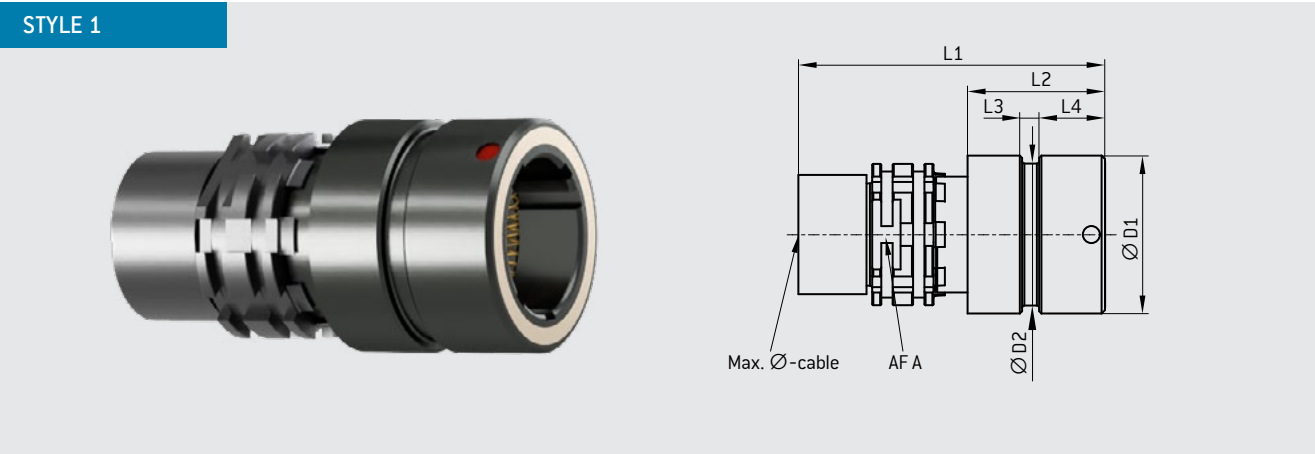

Size		L1 mm	L2 mm	L3 mm	L4 mm	D1 mm	D2 mm	AFA mm	Max Ø-cable ¹ mm
0	0	25.0	13.0	1.5	5.8	11.9	10.5	9	5.5
1	1	27.0	12.1	1.5	5.8	13.9	12.5	11	6.5
1.5	A	27.0	12.0	1.5	5.8	15.9	14.5	12	8.0

TECHNICAL DATA

- Technical data see page 42
- Contact configuration see page 32
- Cable assembly information see ODU instruction 010.645.001.000.003 (available at www.odu-connectors.com/downloads/assembly-instructions/)

¹ Based on cable with one braided shield

1 2 3 4 5 6 7 8 9 10 11 12 13 14 15 16 17 18 19

K | 1 | Y | R | - | P | | | | | 0 | - | R | 0 | 0 | 0

RECEPTACLE

STYLE K



For installation from rear of panel – low profile inside the device

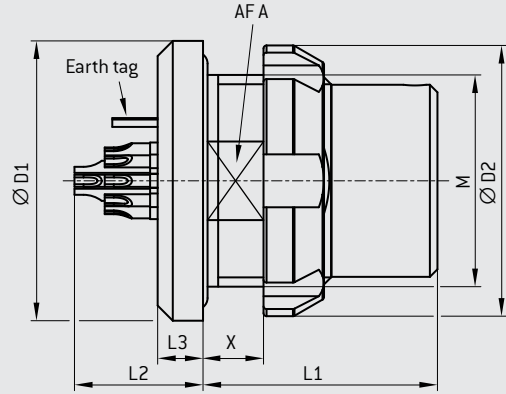

Size		L1 mm	L2 max mm	L3 mm	X max mm	D1 mm	D2 mm	AFA mm	M mm	Panel cut out	
										AF mm	Ø mm
0	0	15.5	7.3	2.5	7.0	15.5	15.0	10	11×0.75	10.1	11.1
1	1	15.5	7.4	3.0	4.0	18.5	17.9	13	14×1	13.1	14.1
1.5	A	16.5	8.2	3.0	5.5	18.9	17.9	13	14×0.75	13.1	14.1

Panel cut out

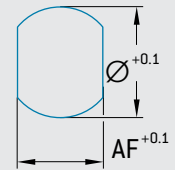

NUTDRIVER FOR SLOTTED NUT

Size	Number	Torque Nm
0	700.098.001.000.000	1.0
1	701.098.002.000.000	3.0
1.5 (A)	701.098.002.000.000	3.0

TECHNICAL DATA

- Technical data see page 42
- Contact configuration see page 32

1 2 3 4 5 6 7 8 9 10 11 12 13 14 15 16 17 18 19

G | K | Y | R | - | P | | | | | | | | | | O | - | R | O | O | L

RECEPTACLE

STYLE 8



For installation from rear of panel – low profile inside the device

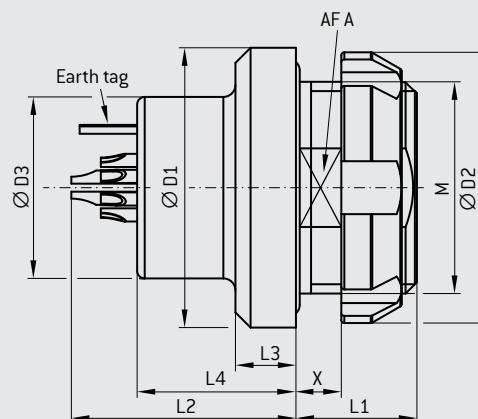

Size		L1 mm	L2 max mm	L3 mm	L4 mm	X max mm	D1 mm	D2 mm	D3 mm	AF A mm	M mm	Panel cut out AF mm	Ø mm
0	0	6.5	16.3	3.0	11.5	3.0	15.5	15.0	10.0	10	11×0.75	10.1	11.1
1	1	8.0	14.9	4.0	10.5	3.5	18.5	17.9	12.0	13	14×1	13.1	14.1
1.5	A	7.0	17.7	2.5	12.5	3.0	18.9	17.9	14.0	13	14×0.75	13.1	14.1

Panel cut out

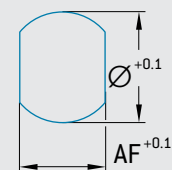

NUTDRIVER FOR SLOTTED NUT

Size	Number	Torque Nm
0	700.098.001.000.000	1.0
1	701.098.002.000.000	3.0
1.5 (A)	701.098.002.000.000	3.0

TECHNICAL DATA

- Technical data see page [42](#)
- Contact configuration and PCB layout see page [32](#)

1 2 3 4 5 6 7 8 9 10 11 12 13 14 15 16 17 18 19

G | 8 | Y | R | - | P | | | | | | | | | | | 0 | - | R | 0 | 0 | L

CODING POSSIBILITIES

HOUSING MATERIAL

Coding	Plug front view	Color coding	Color
A			Light brown
B			Red
C			Blue
D			Green

Coding	Housing material
R	Aluminium EN-6023 Ruthenium over electroless Ni

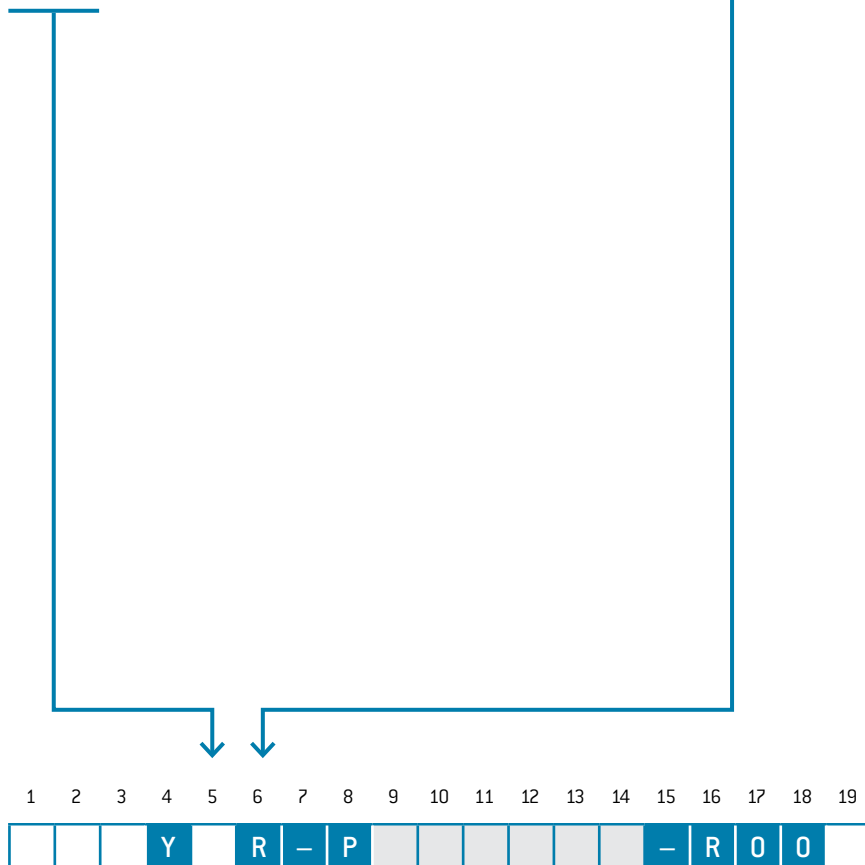

FOR YOUR NOTES

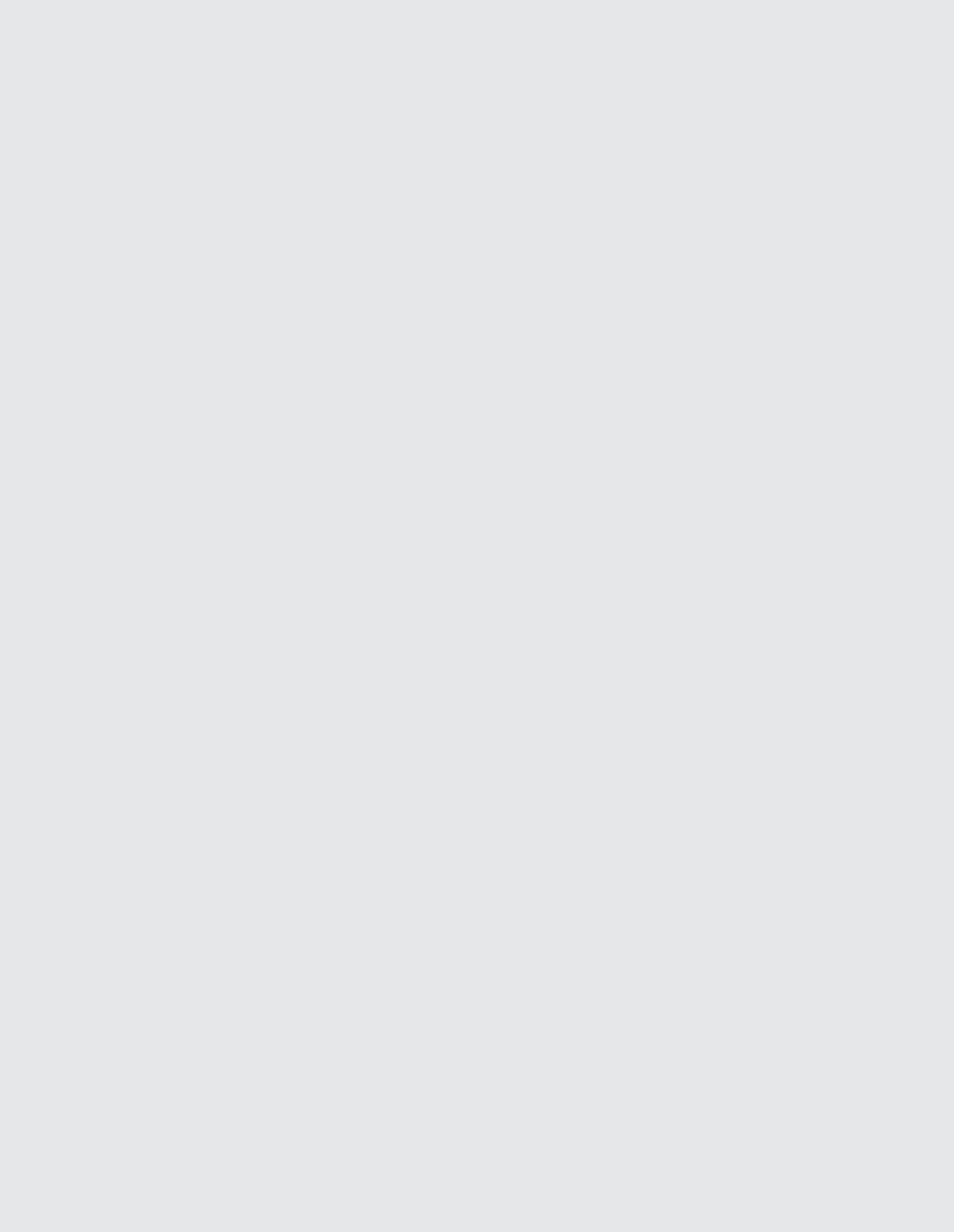

CONTACT CONFIGURATIONS

SIZE 0

Number of contacts ¹		Available connector styles			Contact type		Part number key				Contact diameter mm	Single contact nominal current ² A	Test voltage ³ Contact to contact kVeff	Nominal voltage ⁴ kVrms	Termination		Termination cross section mm ²
						Termination									mm	AWG	
0	4	A1	–	–	Flat contact	Solder	W	D	D	0	0.6	2.0	0.600	0.200	0.65	26	0.15
		–	–	–		Print	U	D	0	0					0.5	–	–
		G8	GK	K1	Spring load contact	Solder	X	D	D	0					0.65	26	0.15
				–		Print	V	D	0	0					0.5	–	–
0	7	A1	–	–	Flat contact	Solder	W	D	D	0	0.6	2.0	0.600	0.200	0.65	26	0.15
		–	–	–		Print	U	D	0	0					0.5	–	–
		G8	GK	K1	Spring load contact	Solder	X	D	D	0					0.65	26	0.15
				–		Print	V	D	0	0					0.5	–	–

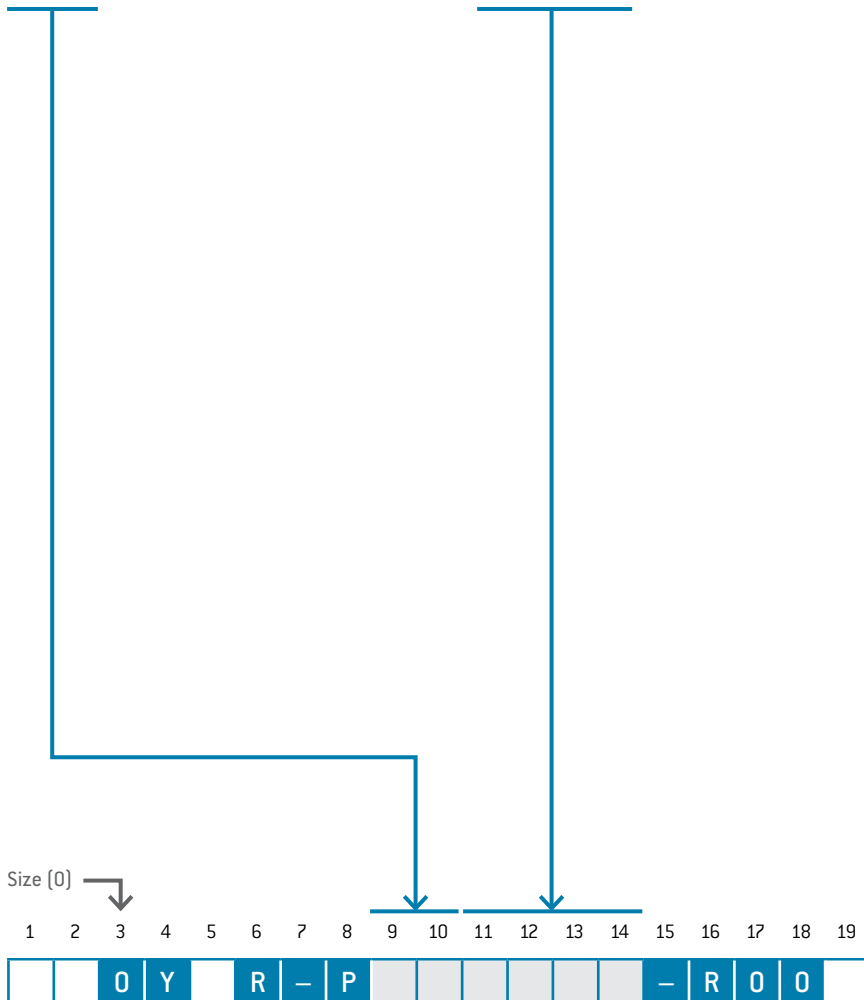

¹ Other contact configurations on request.
² Derating factor see page 47
³ SAE AS 13441:2004 method 3001.1
⁴ Max. operating voltage at NN (sea level) acc. to SAE AS 13441:2004 method 3001.1
 Further information on page 48

PCB LAYOUT PRINT CONTACTS SIZE 0

View on termination area		Number of contacts	Length earth tag and pin	G8 Pin X mm	GK Pin Y mm	GW Pin Z mm
Spring load contact piece	Flat-contact piece					
		4 pos.		4.3	4.3	3.0
		7 pos.			4.3	4.3

LENGTH EARTH TAG AND PIN

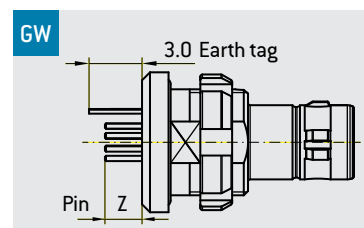
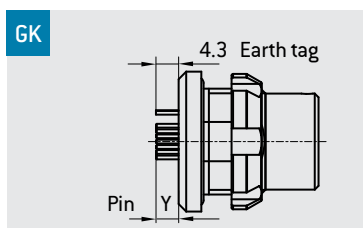
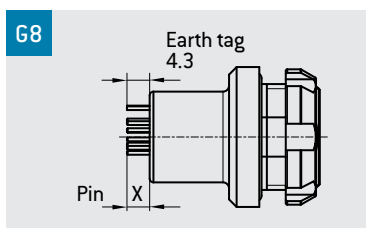

CONTACT CONFIGURATIONS

SIZE 1

Number of contacts ¹		Available connector styles			Contact type		Part number key				Contact diameter mm	Single contact nominal current ² A	Test voltage ³ Contact to contact kVeff	Nominal voltage ⁴ kVrms	Termination		
						Termination	W	D	D	0					mm	AWG	mm ²
1	0	A1	GW	-	Flat contact	Solder	W	D	D	0	0.6	2.0	0.600	0.200	0.65	26	0.15
						Print	U	D	0	0					0.5	-	-
		G8	GK	K1	Spring load contact	Solder	X	D	D	0					0.65	26	0.15
						Print	V	D	0	0					0.5	-	-
1	6	A1	GW	-	Flat contact	Solder	W	D	D	0	0.6	2.0	0.600	0.200	0.65	26	0.15
						Print	U	D	0	0					0.5	-	-
		G8	GK	K1	Spring load contact	Solder	X	D	D	0					0.65	26	0.15
						Print	V	D	0	0					0.5	-	-

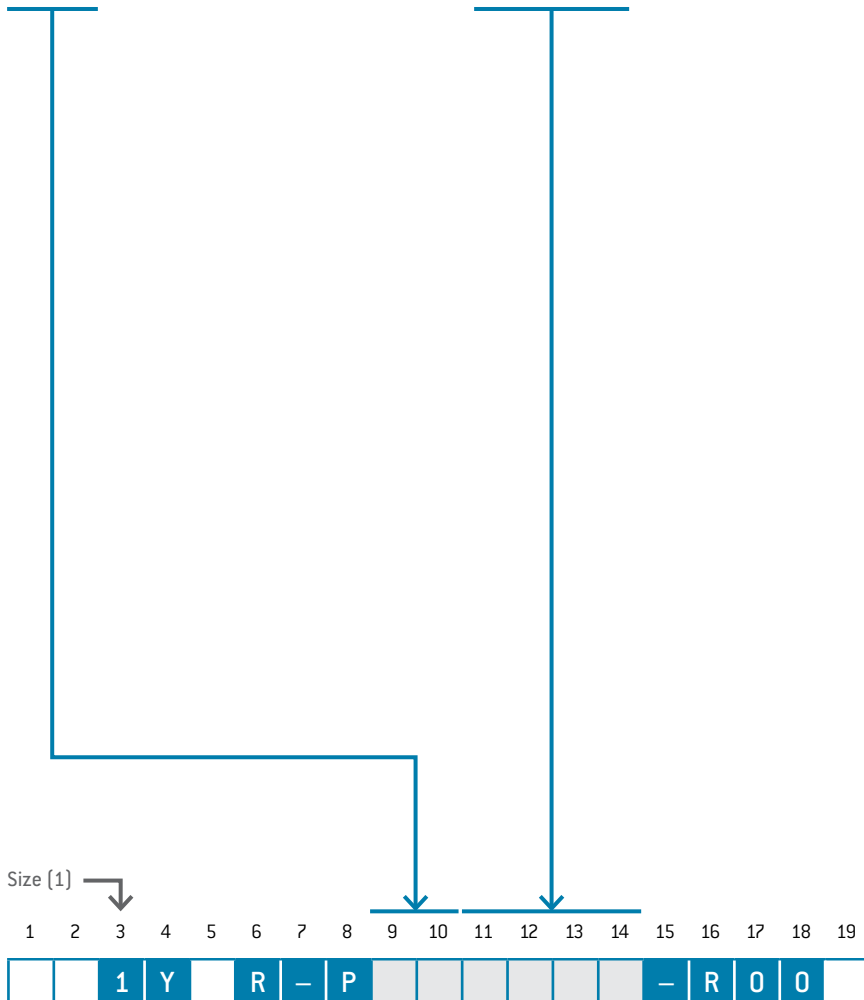

¹ Other contact configurations on request.
² Derating factor see page 47
³ SAE AS 13441:2004 method 3001.1
⁴ Max. operating voltage at NN (sea level) acc. to SAE AS 13441:2004 method 3001.1
 Further information on page 48

PCB LAYOUT PRINT CONTACTS SIZE 1

View on termination area		Number of contacts	Length earth tag and pin			
Spring load contact piece	Flat-contact piece		G8 Pin X mm	GK Pin Y mm	GW Pin Z mm	
		10 pos.		3.9	3.9	3.0
		16 pos.		3.9	3.9	3.0

LENGTH EARTH TAG AND PIN

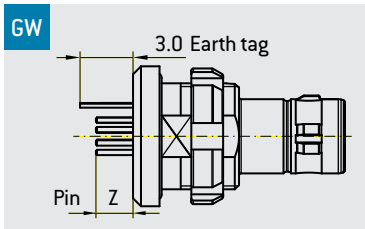
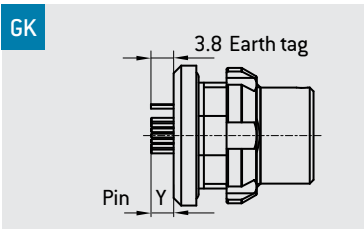
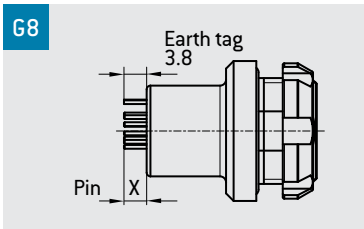

CONTACT CONFIGURATIONS

SIZE 1.5

Number of contacts ¹		Available connector styles			Contact type		Part number key				Contact diameter mm	Single contact nominal current ² A	Test voltage ³ Contact to contact kVeff	Nominal voltage ⁴ kVrms	Termination		
						Termination									mm	AWG	mm ²
1	9	A1	GW	-	Flat contact	Solder	W	D	D	0	0.6	2.0	0.600	0.200	0.65	26	0.15
		Print				U	D	0	0	0.5					-	-	
		G8	GK	K1	Spring load contact	Solder	X	D	D	0					0.65	26	0.15
				Print		V	D	0	0	0.5					-	-	

¹ Other contact configurations on request
² Derating factor see page 47
³ SAE AS 13441:2004 method 3001.1
⁴ Max. operating voltage at NN (sea level) acc. to SAE AS 13441:2004 method 3001.1
 Further information on page 48

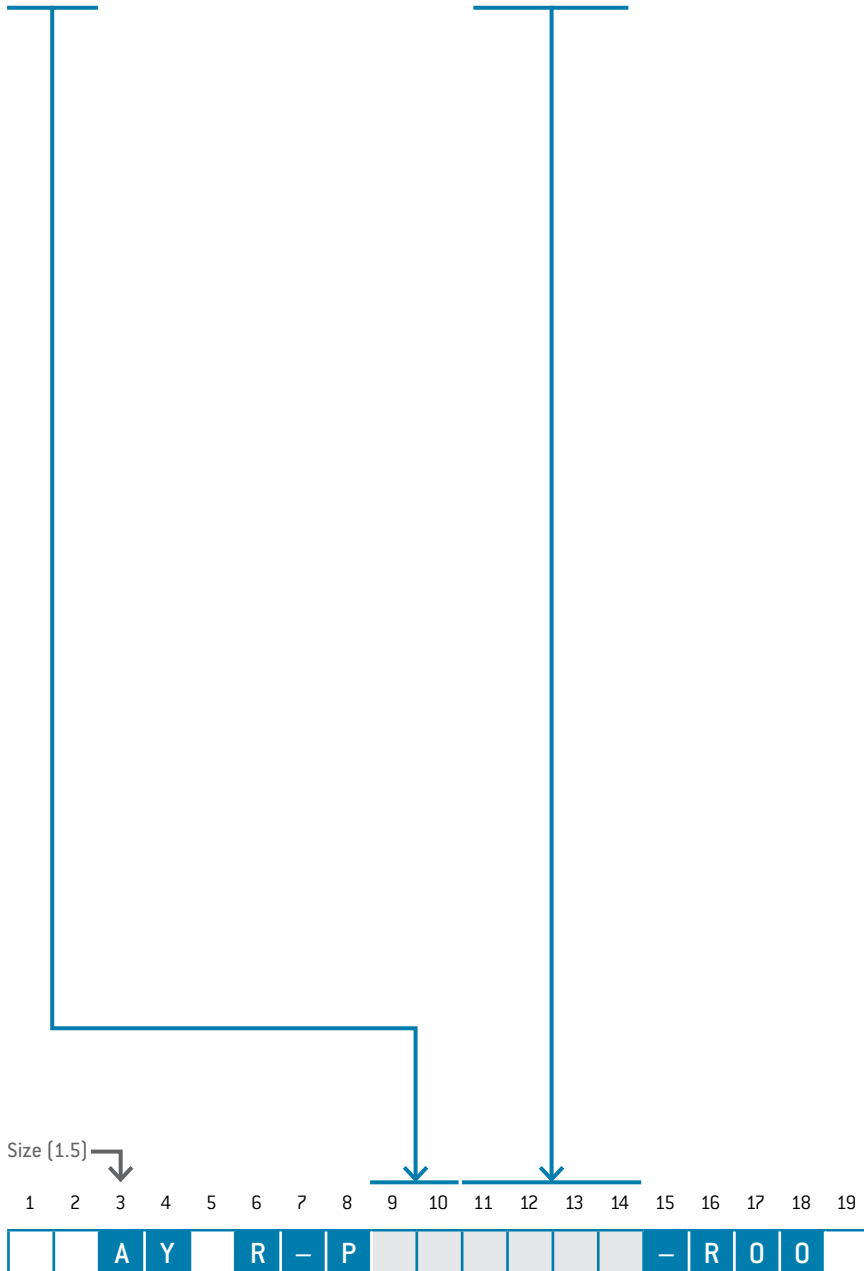

PCB LAYOUT PRINT CONTACTS SIZE 1.5

View on termination area		Number of contacts		Length earth tag and pin		
Spring load contact piece	Flat-contact piece			G8 Pin X mm	GK Pin Y mm	GW Pin Z mm
		19 pos.	3.5	3.5	1.5	

LENGTH EARTH TAG AND PIN

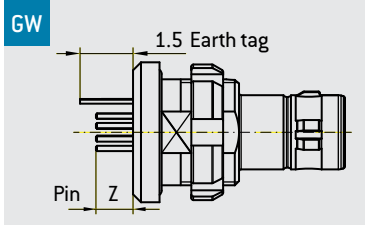
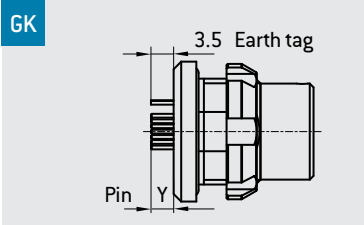
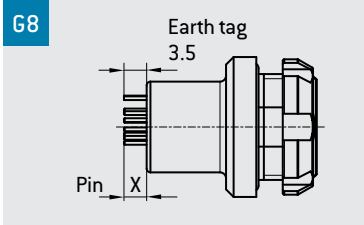

DUST PROTECTION CAPS

ENVIRONMENTAL AND ELECTRICAL CHARACTERISTICS

Type	Performance	Standard
Protection	IP5K0	ISO 20653:2013
Operating temperature	-51 °C to +125 °C	IEC 60512-11-9:2002 IEC 60512-11-10:2002
Shielding effectiveness	> 55 dB	VG 95214-11

MATERIAL

Part	Material	Flammability
Cap	Conductive silicone	UL94 (V1)
Lanyard	Aramid	UL94 (V0)
Crimp ferrule, lug	Brass, copper	

Assembly information including tools see ODU instruction 010.645.001.000.005 (available at www.odu-connectors.com/downloads/assembly-instructions)

FOR RECEPTACLES G8 AND GK AND IN-LINE RECEPTACLE K1

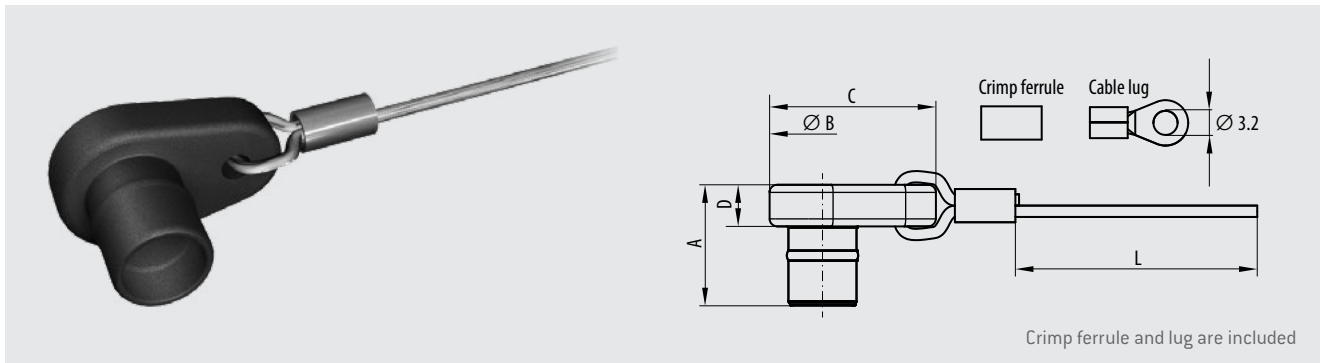

Size	Part number	Dimensions in mm				
		A	B	C	D	L
0	700.645.097.002.945	15.5	12.0	20.0	5.5	200
1	701.645.097.002.945	16.0	14.0	22.0	5.5	200
1.5	715.645.097.002.945	15.3	15.0	23.0	5.5	200

FOR YOUR NOTES

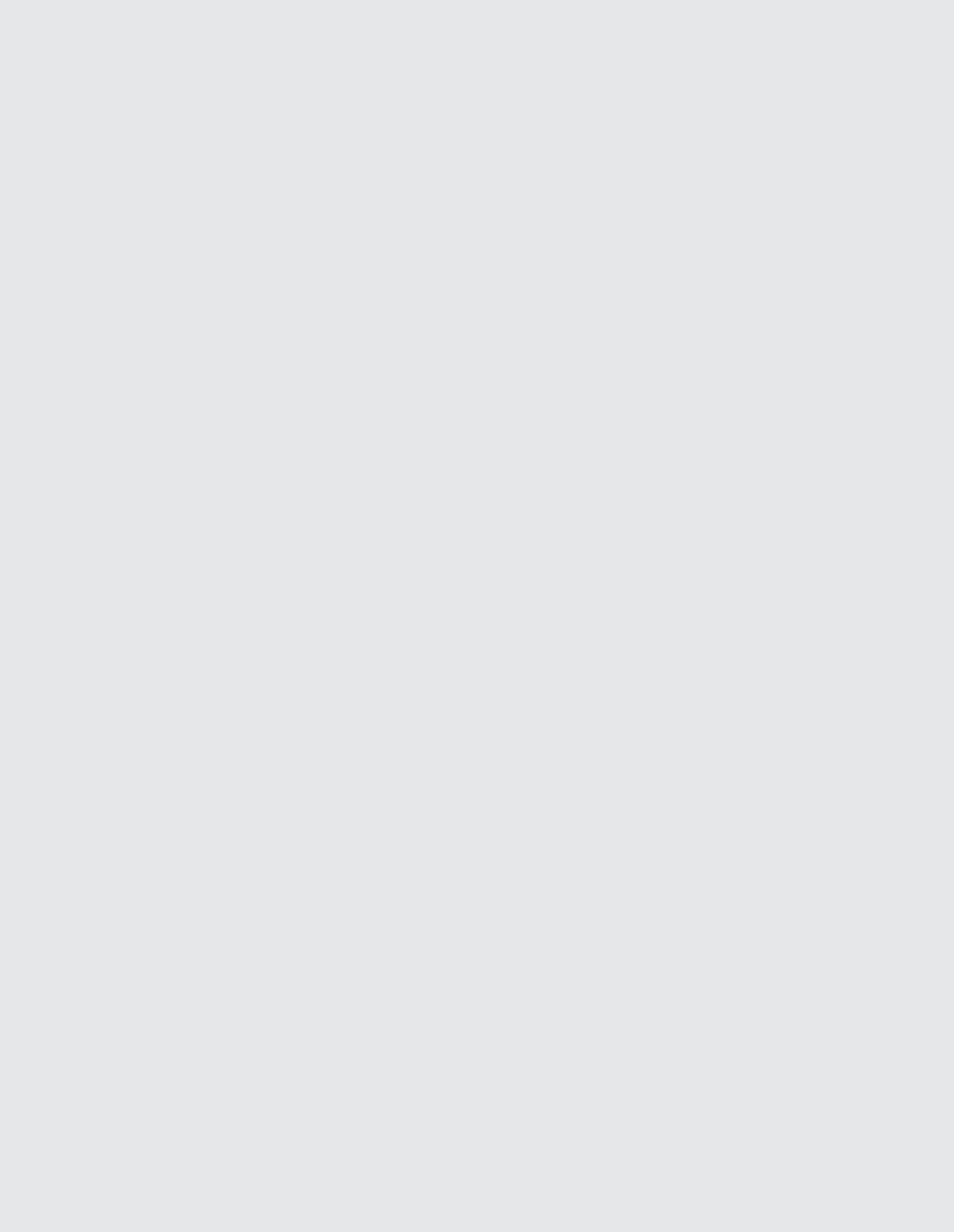

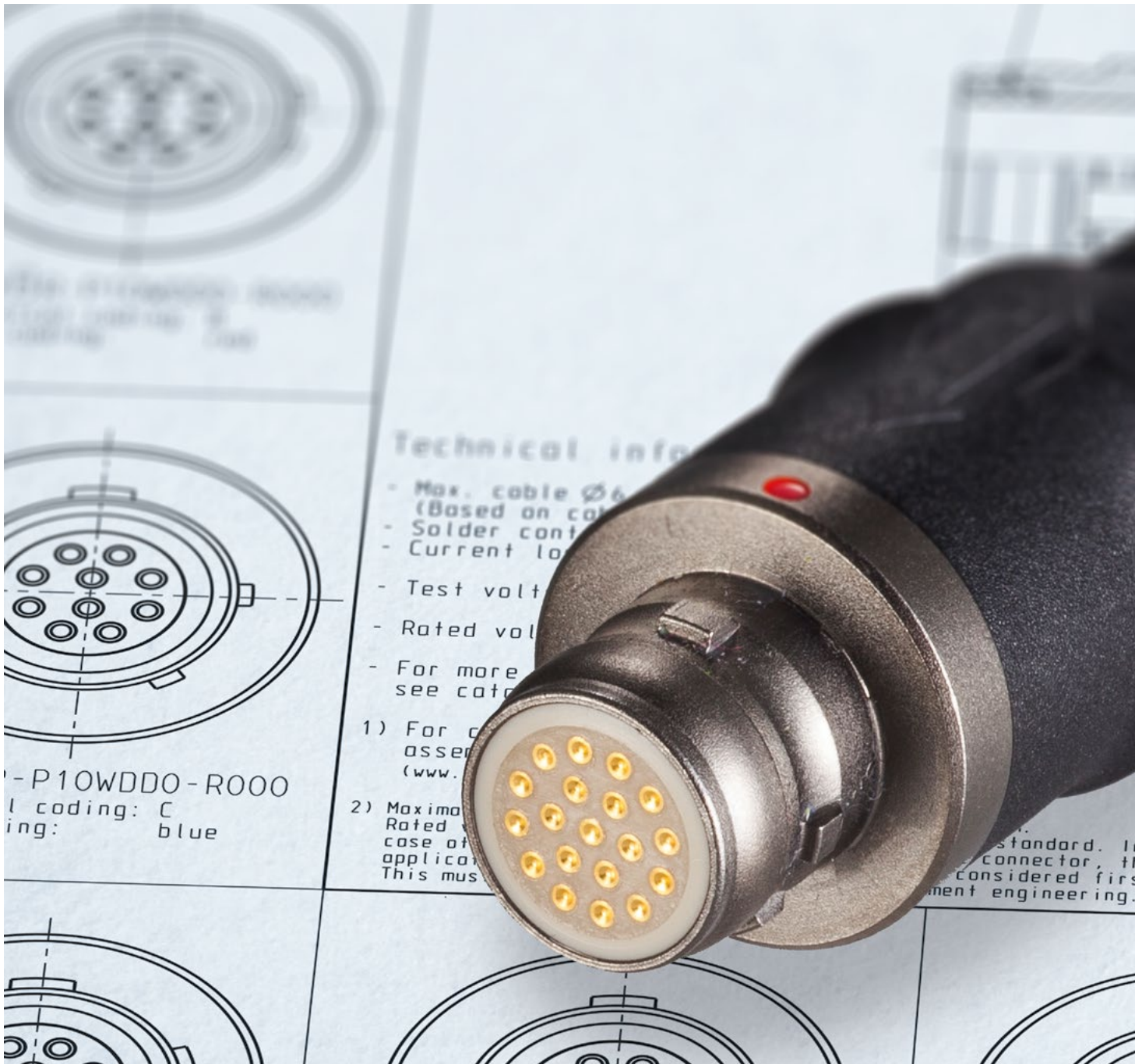

Technical info

- Max. cable Ø 6 (Based on cable)
- Solder contact
- Current load
- Test voltage
- Rated voltage
- For more information see catalog

- 1) For cable assembly (www. ...)
- 2) Maximum Rated voltage in case of application. This must be considered first.

P10WDDO-R000
Coding: C
Color: blue

standard. In case of connector, this should be considered first. Contact your nearest engineering.

ODU AMC® EASY-CLEAN

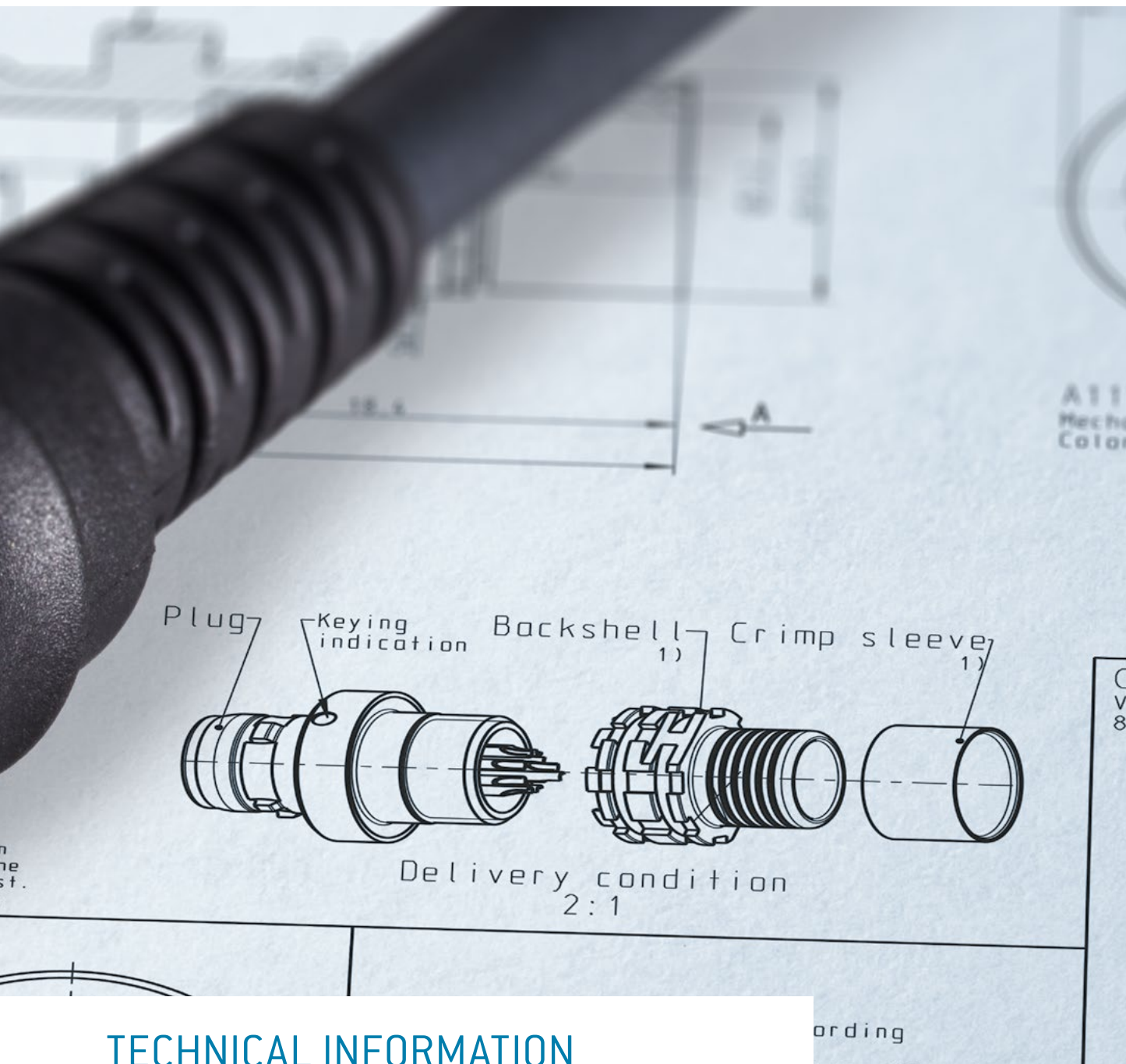

TECHNICAL INFORMATION

Technical data	42
Protection	44
International protection classes	45
Spring loaded contact	46
Current load contact	47
Operating voltage	48
Conversion / AWG	50
Technical terms	51

TECHNICAL DATA

ENVIRONMENTAL AND TESTING

Type	Performance	Standard
Tightness	IPX8 / 1m 120 min IPX9K	ISO 20653:2013 / MIL-STD-810G:2008 512.5 ISO 20653: 2013
Sand and dust	Blowing sand and dust IP6KX (settling dust)	MIL-STD-810G:2008 510.5 Procedure I / II ISO 20653:2013
Operating temperature	-51 °C up to +125 °C ¹	IEC 60512-11-9:2002 IEC 60512-11-10:2002
Thermal shock	-65 °C up to +150 °C	EIA 364-32-E, IEC 60068-2-14
Humidity cyclic	85 % up to 95 %, 28 °C up to 71 °C	MIL-STD-1344A Method 1002.2 Type III, IEC 60068-2-38
Low pressure (rapid decompression)	59.1 kPa to 18.8 kPa	AECTP 300, 312 Procedure III (STANAG 4370)
Low pressure	57.2 kPa, -55 °C	MIL-STD-810G:2008 500.5 IEC 60068-2-40
Icing	Rime ice 6 mm	MIL-STD-810G:2008 521.3
Corrosion resistance	96 h salt mist, 5 % salt solution, 35 °C	EIA-364-26B STANAG 4370, AECTP 300-309 MIL-STD-810G:2008 509.5
Mould growth	European fungus	IEC 60068-2-10:2005
Solar radiation		IEC 60068-2-5:2018
Chemical endurance	Several substances ²	ISO 16750-5:2010-04

¹ Including temperature rise due to contact load

² Substances listed at ODU datasheet 009.410.021.000.000

RoHS 2011/65/EC recognized

MECHANICAL DATA

Type	Performance	Standard
Mechanical endurance	5,000 mating cycles ¹	IEC 60512-5-9-a EIA-364-09
Vibration		MIL-STD 1344 Method 2005 EIA-364-28
Shock	100 g amplitude, half sine pulse of 3 ms, no discontinuity > 1 μs	MIL-STD 1344 Method 2004 EIA-364-27

¹ 5,000 mating cycles, dependent on the specific application

ELECTRICAL DATA

Type	Performance	Standard
Contact resistance (fig. 1) over 5,000 mating cycles	Contact diameter / resistance Ø 0.6 mm pogo pin < 20 mΩhm	IEC 60512-2-1:2002
Shell resistance (fig. 2)	< 10 mΩhm	IEC 60512-2-1:2002
Insulation resistance	> 100 MΩhm	IEC 60512-3-1:2002

MEASUREMENT POINTS

FIG. 1

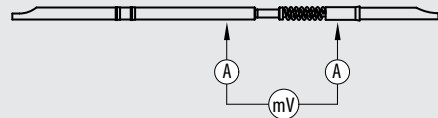
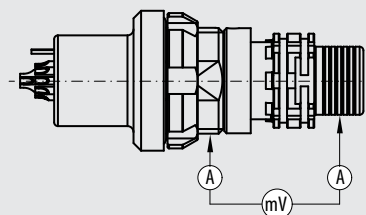

FIG. 2



MATERIAL AND SURFACE TREATMENTS

Type	Material	Standard		Surface	Standard	Flammability
		EU	US			
Housing (conductive parts)	Aluminium AlMgSiSn1Bi	EN-AW 6023		Ruthenium over electroless nickel		
Nut	Aluminium AlMgSiSn1Bi	EN-AW 6023		Black anodized		
Backshell	Aluminium AlMgSiSn1Bi	EN-AW 6023		Electroless nickel	SAE-AMS2404	
EMI-locking ring	Stainless steel	CW102C (2.1248)		Electrodeposited gold		
Crimp sleeve	CuZn38Pb1.5	CW608N (2.0371)	C35300	Electrodeposited nickel		
Color ring	PSU					UL94 (V0)
Insulator	PEEK					UL94 (V0)
Pin contact (pogo-pin)	Copper alloy, CuBe, steel,			1.27 µm gold over electro-deposited nickel (on piston)	MIL-G-45204D	
Socket contact	Copper alloy	CW614N (2.0401)	C38500	1.27 µm gold over electrodeposited nickel	MIL-G-45204D	
O-rings	FVMQ (floursilikon)					
Potting	Potting compound					UL94 (V0)
Overmolding material	TPU					UL94 (HB)
Shrink boots	Polyester-elastomere					Acc. to VG95343



PROTECTION OF ODU AMC® EASY-CLEAN

IP RATING ACC. TO ISO 20653:2013
 IMMERSION ACC. TO MIL-STD-810G 512.5
 SAND AND DUST ACC. TO MIL-STD-810G 510.5

OPEN FACE	BREAK-AWAY PLUG	IPX8 ²
	PANEL MOUNT PLUG	
	IN-LINE RECEPTACLE	
	PANEL MOUNT RECEPTACLE	

MATED WITH RUBBER CAP	IN-LINE RECEPTACLE	IP5K0 ¹
	PANEL MOUNT RECEPTACLE	

¹ Full protection
² Contact area not protected

MATED	PLUG WITH PANEL MOUNT RECEPTACLE	IP6K8 / IP6K9K IMMERSION / SAND AND DUST ACC. TO MIL ¹
	PLUG WITH IN-LINE RECEPTACLE	
	PANEL MOUNT PLUG WITH-LINE RECEPTACLE	

The protection is only assured when backshell potted during cable assembly, according to ODU AMC® assembly instructions.

INTERNATIONAL PROTECTION CLASSES

ISO 20653:2013 (VDE 0470-1:2014-09)

Code letters (International Protection)		First code number (Degrees of protection against access to hazardous parts respectively against solid foreign objects)		Second code number (Degrees of protection against water)		
IP		6		5		
Code no.	Protection against access to hazardous parts / Protection against ingress of solid foreign objects			Code no.	Protection against harmful effects due to the ingress of water	
0	No protection		No protection against contact / No protection against solid foreign objects	0	No protection against water	No protection against water
1	Protection against contact with the back of hand (no protection against intentional contact)		Test probe with diameter 50 mm shall not penetrate completely and maintain sufficient distance from hazardous parts.	1	Protection against dripping water	Vertical drips shall not have any harmful effects or impair performance.
2	Protection against finger contact		Jointed test finger with diameter 12.5 mm may penetrate completely, but shall maintain a sufficient distance from hazardous parts.	2	Protection against dripping water (tilted)	Vertical drips shall not have any harmful effects or impair performance when the enclosure is tilted at any angle up to 15° on either side of the vertical
3	Protection against penetration of tools (e.g. screwdrivers)		Test probe with diameter 2.5 mm, may penetrate completely, but shall maintain a sufficient distance from hazardous parts.	3	Protection against spray water	Water spray at an angle up to 60° on either side of the vertical shall have no harmful effects or impair performance
4	Protection against granular foreign objects		Test probe with diameter 1.0 mm, may penetrate completely, but shall maintain a sufficient distance from hazardous parts	4	Protection against splashing water	Water which splashes against the enclosure from any direction shall not have any harmful effects or impair performance
				4K	Protection against splashing water with increased pressure	Water which splashes against the enclosure from any direction with increased pressure shall not have any harmful effects or impair performance
5K	Protection against dust		Dust shall only penetrate in quantities which do not impair performance and safety.	5	Protection against high-velocity water	Water which is directed against the enclosure from any direction as a jet shall not have any harmful effects or impair performance
				6	Protection against powerful water jet	Water which is directed against the enclosure from any direction as a strong jet shall not have any harmful effects or impair performance
6K	Protection against ingress of dust		Dust shall not penetrate	6K	Protection against strong high-velocity water with increased pressure	Water which is directed against the enclosure from any direction as a strong jet with increased pressure shall not have any harmful effects or impair performance
				7	Protection against the effects of temporary immersion in water	Water shall not penetrate in a quantity causing harmful effects or impair performance if the enclosure is immersed in water temporarily under specified pressure and time conditions
				8	Protection against the effects of continuous immersion in water	Water shall not penetrate in a quantity causing harmful effects if the enclosure is continuously immersed in water under conditions which shall be specified by the manufacturer
				9K	Protection against water during high-pressure/steam-jet cleaning	Water which is directed against the enclosure from any direction shall not have any harmful effects or impair performance

SPRING LOADED CONTACT

The contacts within the ODU AMC® Easy-Clean series are patented spring loaded contacts made by a leading swiss manufacturer.

Mating cycles	> 5,000
Material	Piston Gold plated machined brass
	Barrel Tin plated machined brass
	Spring Stainless steel
	CIIP Gold plated BeCu C17200

	Plug	Receptacle
Solder termination	●	●
PCB termination	●	●

Information on diameters, terminal types and current-carrying capacity can be found after the inserts.

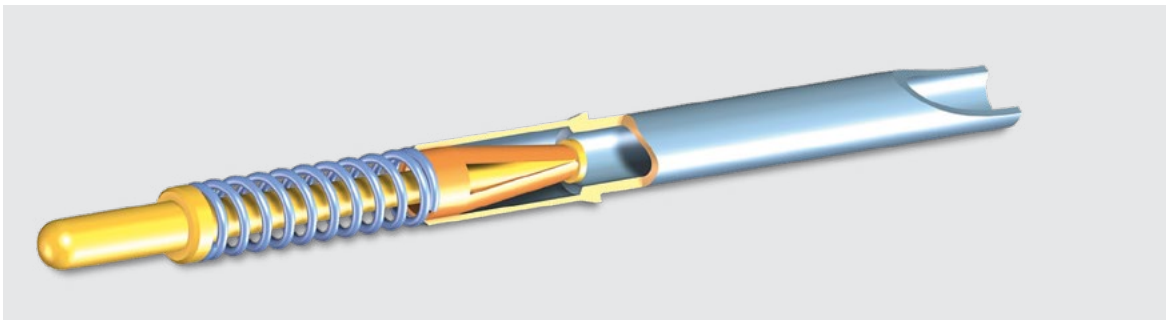

CURRENT LOAD OF SPRING LOADED CONTACT

NOMINAL SINGLE CONTACT CURRENT LOAD FOR SPRING LOAD CONTACT (PISTON DIAMETER 0.6 mm)

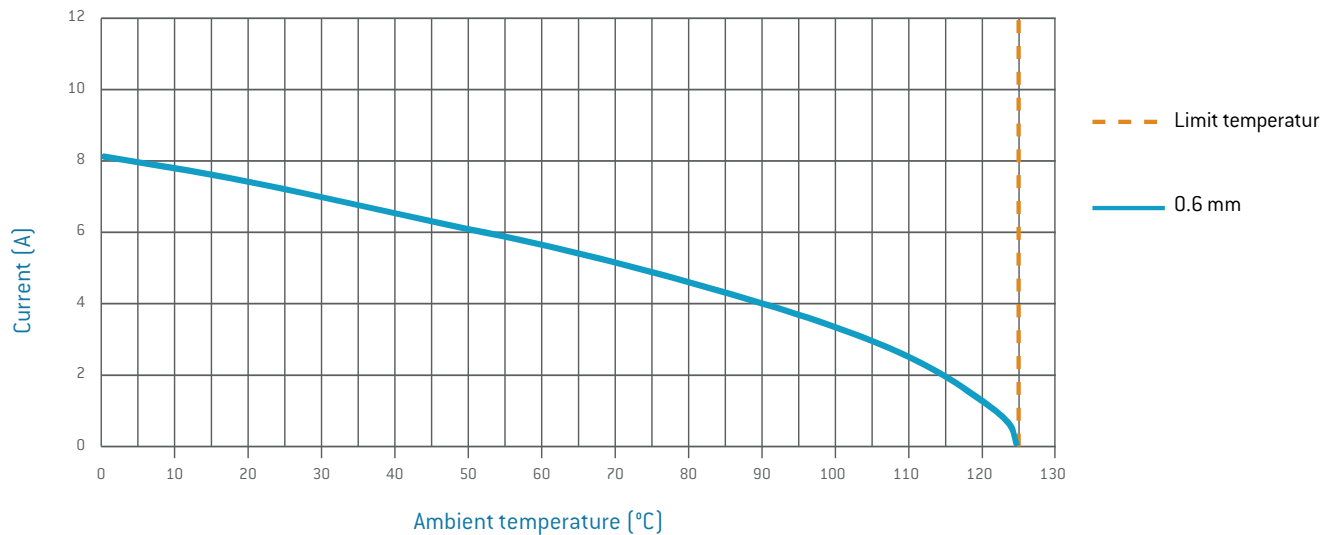

UPPER LIMIT TEMPERATURE OF SPRING LOAD CONTACT: +125 °C

In the case of multi-position connectors and cables, the heating is greater than it is with individual contacts. For that reason, it is calculated with a derating factor.

For connectors, the derating factors for multi-core cables pursuant to VDE 0298-4:2013-06 are applied. The derating factor is factored in at 5 live wires and up.

DERATING CURVE

The corrected current-carrying capacity curve, derived from the base curve determined (0.8 × measured current). It factors in manufacturing tolerances as well as uncertainties in temperature measurement and measurement arrangement. See derating measurement method.

DERATING FACTOR

Number of loaded wires	Derating factor
5	0.75
7	0.65
10	0.55
14	0.50
19	0.45

OPERATING VOLTAGE

ACC. TO SAE AS 13441-METHOD 3001.1

The values acc. to SAE AS 13441:2004-method 3001.1 comply with MIL-Std. 1344 – method 3001.

The inserts have been tested in mated condition and the test voltage was applied to the pin insert.

75 % of the measured break-down voltage is the basic for the further calculation. $\frac{1}{3}$ of this value is the corresponding operating voltage.

All tests were performed at standard environment conditions (room temperature) and can be applied up to an altitude of 2,000 m. For any deviations one has to consider the reduction factor acc. to the relevant standards.

Test voltage	Break-down voltage $\times 0.75$
Operating voltage	Break-down voltage $\times 0.75 \times 0.33$

Suitable safety precautions must be taken in order to ensure that personnel do not come into contact with live conductors during installation and operation.

All entries were reviewed with maximum care before this catalogue was printed.

ODU reserves the right to make changes in accordance with the current state of the art without advance notice, and without being obligated to provide replacement deliveries or to continue production of older designs.

CAUTION

Electrical appliances: for various applications the safety requirements regarding the operating voltage is even more severe!

The relevant datas in such cases for the operating voltage are the creepage and clearance distances. For any advise how to chose the proper connector please consult us and indicate the safty standard which your product has to meet.

FOR YOUR NOTES

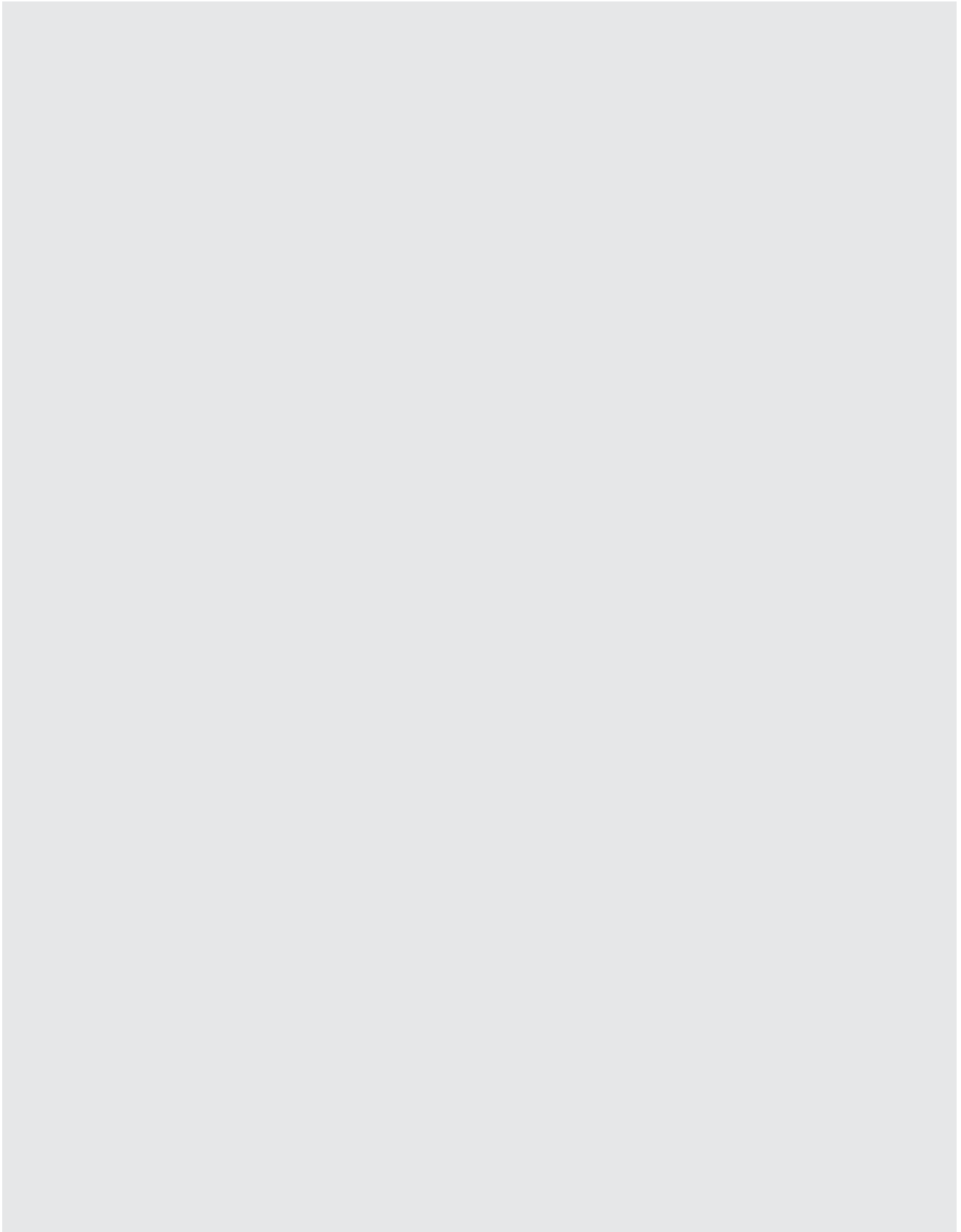

CONVERSIONS / AWG (AMERICAN WIRE GAUGE)

Circular wire					
AWG	Diameter		Cross-section mm ²	Weight kg / km	Max. resistance Ω / km
	Inch	mm			
10 (1)	0.1019	2.590	5.26	46.77	3.45
10 (37/26)	0.1150	2.921	4.74	42.10	4.13
12 (1)	0.0808	2.050	3.31	29.41	5.45
12 (19/25)	0.0930	2.362	3.08	27.36	6.14
12 (37/28)	0.0910	2.311	2.97	26.45	6.36
14 (1)	0.0641	1.630	2.08	18.51	8.79
14 (19/27)	0.0730	1.854	1.94	17.23	9.94
14 (37/30)	0.0735	1.867	2.08	18.870	10.50
16 (1)	0.0508	1.290	1.31	11.625	13.94
16 (19/29)	0.0590	1.499	1.23	10.928	15.70
18 (1)	0.0403	1.020	0.823	7.316	22.18
18 (19/30)	0.0052	1.321	0.963	8.564	20.40
20 (1)	0.0320	0.813	0.519	4.613	35.10
20 (7/28)	0.0390	0.991	0.563	5.003	34.10
20 (19/32)	0.0420	1.067	0.616	5.473	32.00
22 (1)	0.0253	0.643	0.324	2.883	57.70
22 (7/30)	0.0288	0.732	0.324	2.965	54.80
22 (19/34)	0.0330	0.838	0.382	3.395	51.80
24 (1)	0.0201	0.511	0.205	1.820	91.20
24 (7/32)	0.0250	0.635	0.227	2.016	86.00
24 (19/36)	0.0270	0.686	0.241	2.145	83.30
26 (1)	0.0159	0.404	0.128	1.139	147.00
26 (7/34)	0.0200	0.508	0.141	1.251	140.00
26 (19/38)	0.0220	0.559	0.154	1.370	131.00
28 (1)	0.0126	0.320	0.0804	0.715	231.00
28 (7/36)	0.0160	0.406	0.0889	0.790	224.00
28 (19/40)	0.0170	0.432	0.0925	0.823	207.00
30 (1)	0.0100	0.254	0.0507	0.450	374.00
30 (7/38)	0.0130	0.330	0.0568	0.505	354.00
30 (19/42)	0.0123	0.312	0.0720	0.622	310.00
32 (1)	0.0080	0.203	0.0324	0.288	561.00
32 (7/40)	0.0110	0.279	0.0341	0.303	597.10
32 (19/44)	0.0100	0.254	0.0440	0.356	492.00
34 (1)	0.0063	0.160	0.0201	0.179	951.00
34 (7/42)	0.0070	0.180	0.0222	0.197	1,491.00
36 (1)	0.0050	0.127	0.0127	0.1126	1,519.00
36 (7/44)	0.0060	0.150	0.0142	0.1263	1,322.00

The American Wire Gauge (AWG) is based on the principle that the cross-section of the wire changes by 26 % from one gauge number to the next. The AWG numbers decrease as the wire diameter increases, while the AWG numbers increase as the wire diameter decreases. This only applies to solid wire.

However, stranded wire is predominately used in practice. This has the advantage of a longer service life under bending and vibration as well as greater flexibility in comparison with solid wire.

Stranded wires are made of multiple, smaller-gauge wires (higher AWG number). The stranded wire then receives the AWG numbers of a solid wire with the next closest cross-section to that of the stranded wire. In this case, the cross-section of the stranded wire refers to the sum of the copper cross-sections of the individual wires.

Accordingly, strands with the same AWG number but different numbers of wires differ in cross-section. For instance, an AWG 20 strand of 7 AWG 28 wires has a cross-section of 0.563 mm², while an AWG 20 strand of 19 AWG 32 wires has a cross-section of 0.616 mm².

Source: ASTM

TECHNICAL TERMS

AMBIENT TEMPERATURE

Temperature of the air or other medium in which a piece of equipment is intended to be used in (IEC 44/709/CDV:2014 (VDE 0113-1:2019-06)).

AWG

American Wire Gauge. See page [50](#).

BASE CURVE

A current-carrying capacity curve metrologically determined according to the method described in IEC 60512-5-2:2002 (DIN EN 60512-5-2:2003-01) depending on the permissible limit temperature of the materials.

CHEMICAL RESISTANCE

Many secondary processing procedures use adhesives, cleaning agents or other chemicals on our products. Contact with unsuitable chemicals may have an adverse effect on the mechanical and electrical properties of the insulation and housing materials which specified properties may not be able to withstand. Please observe our processing suggestions and technical instructions in this catalogue.

CLEARANCE DISTANCE

The shortest distance in the air between two conductive parts.

CODING (ORIENTATION)

Arrangement with which differing polarization of otherwise identical connectors prevents interchangeability. This is a good idea if two or more identical connectors are attached to the same device. See also compatible connectors, see page [30](#).

CONNECTORS

Also known as connectors without contact rating (COC): (IEC 61984:2008 (VDE 0627:2009-11)). An element which enables electrical conductors to be connected and is intended to create and/or separate connections with a suitable counterpart.

CONNECTOR WITHOUT BREAKING CAPACITY (COC)

Connector which is not deemed to be engaged or disengaged in normal use when live or under load.

CONTACT RESISTANCE

Total resistance value measured from terminal to terminal. In this case, the resistance is significantly lower than the contact resistance. The specifications are average values.

CORES

Electrical conductor, solid wire or multi-wire strand, with insulation as well as any conductive layers. Cables or leads may have one or more cores.

CREEPAGE DISTANCES

The shortest distance between two conductive parts along the surface of a solid insulation material. This factors in all elevations and recesses in the insulator, as long as defined minimum dimensions are on hand.

CRIMP BARREL

A terminal sleeve which can accommodate one or more conductor and be crimped by a crimping tool.

CRIMP CONNECTION (CRIMP TERMINATION)

The permanent, non-detachable and solder-free mounting of a contact to a conductor via deforming or shaping under pressure to make a good electrical and mechanical connection. Executed with crimping tool, press or automatic crimping machine.

CRIMPING AREA

The specified area of the crimp barrel in which the crimp termination is executed by means of deforming or shaping the barrel under pressure around the conductor.

DEGREE OF POLLUTION

The effect of pollution is factored in as degree of pollution when measuring clearance and creepage distances. Four degrees of pollution are defined for the micro-environment: IEC 60664-1:2007 (VDE 0110-1:2008-01).

DELIVERY FORM

Connectors can be delivered in assembled form or as individual parts.

TECHNICAL TERMS

DERATING CURVE

See page [47](#).

DERATING FACTOR

According to VDE 0298-4:2013-06, with connectors and cables over 5 contacts, the heating is greater than it is with individual contacts. For that reason, the aforementioned standard is calculated with a derating factor.

DERATING MEASUREMENT METHOD IEC 60512-5-2:2002 (DIN EN 60512-5-2:2003-01)

Measurement method to determine the current-carrying capacity of connectors in consideration of the maximum permissible limit temperature. See page [47](#).

FIXED CONNECTORS

Intended for mounting on a fixed surface such as a frame, dock, device or wall (with ODU also receptacle or panel mounted plug).

FREE CONNECTORS

Intended for mounting on free ends of mobile leads and cables (with ODU also connectors, plugs, in-line receptacles).

INSULATOR

Part of a connector which separates conductive parts with different potentials from one another; usually identical to the contact carrier.

LOWERMOST LIMIT TEMPERATURE

The lowest permissible temperature at which a connector may be operated.

MATERIALS (STANDARD MODEL)

See page [43](#).

MATING AND DEMATING FORCE

The force required to fully mate or demate pluggable elements without the influence of a coupling or locking device.

MATING CYCLES

Mechanical actuation of connectors via push and pull action. A mating cycle consists of one mating and demating action. ODU's standard value for the ODU AMC® series is 5,000 mating cycles.

MAX. CONTINUOUS CURRENT

The metrologically determined amperage at room temperature (approx. 20 °C) which increases the contact temperature to the limit temperature. The values specified in the catalog apply to either individual contacts or completely assembled inserts / modules, as indicated.

NOMINAL SINGLE CONTACT CURRENT LOAD

The current-carrying capacity which each individual contact can be loaded with on its own. See page [47](#).

NOMINAL VOLTAGE

The voltage which the manufacturer specifies for a connector and which the operating and performance features relate to.

OPERATING TEMPERATURE FOR ODU AMC® EASY-CLEAN

Range between the uppermost and lowermost temperature limits; –51 °C to +125 °C. See page [42](#).

PCB (A.K.A. "PRINTED CIRCUIT BOARD")

A PCB is a carrier for electronic components. It serves the purposes of mechanical mounting and electrical connection.

PCB TERMINATION

Production of a conductive connection between the PCB and an element in through-hole assembly, THT (through-hole technology).

RATED CURRENT (NOMINAL CURRENT)

See page [47](#).

TECHNICAL TERMS

SOLDER CONNECTION (SOLDER TERMINATION)

Termination technology in which a molten additional metal (solder) with a lower melting point than the base materials to be connected is used to attach two metallic materials to one another.

TIGHTNESS IEC 60529:2013 (VDE 0470-1:2014-09)

See protection classes on page [45](#).

TERMINATION CROSS-SECTION

The specified cross-sections correspond to a “fine-wire” conductor structure pursuant to DIN EN 60228:2005-09 (VDE 0295:2005-09; class 5) or a “fine-wire” conductor structure (7/19 wire) according to AWG (ASTM B258:2014).

TERMINATION TECHNOLOGIES

Methods for connecting the leads to the electro-mechanical element, such as solder-free connections pursuant to IEC 60352 (DIN EN 60352): crimp, screw connection etc. or soldering connection. See page [46](#).

TEST VOLTAGE

The voltage which a conductor can withstand under defined conditions without dielectric breakdown or flashover.

UPPERMOST LIMIT TEMPERATURE

The maximum permissible temperature at which a connector may be operated. It includes contact heating through current-carrying capacity.

WIRE

Wires (solid conductors) are available with an insulator sleeve and/or electrical shielding. Cables or conductors may be made up of one or more wires.

GENERAL NOTE

The connectors listed in this catalogue are intended for use in high voltage and frequency ranges. Suitable precautionary measures must be taken to ensure that people do not come into contact with live conductors during installation and operation. All entries in this catalogue were thoroughly reviewed before printing. ODU reserves the right to make changes based on the current state of knowledge without prior notice without being obliged to provide replacement deliveries or refinements of older designs.

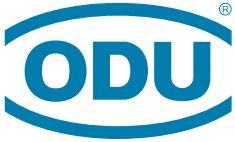

A PERFECT ALLIANCE.

ODU GROUP WORLDWIDE

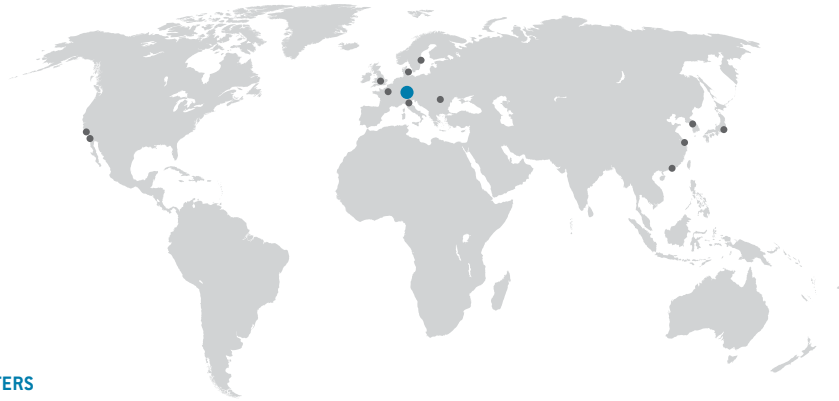

HEADQUARTERS

ODU GmbH & Co. KG

Pregelstraße 11, 84453 Mühldorf a. Inn, Germany
Phone: +49 8631 6156-0, Fax: +49 8631 6156-49, E-mail: sales@odu.de

SALES LOCATIONS

ODU (Shanghai)

International Trading Co., Ltd.
Phone: +86 21 58347828-0
E-mail: sales@odu.com.cn
www.odu.com.cn

ODU Italia S.R.L.

Phone: +39 331 8708847
E-mail: sales@odu-italia.it
www.odu-italia.it

ODU Scandinavia AB

Phone: +46 176 18262
E-mail: sales@odu.se
www.odu.se

ODU (HK) Trading Co., Ltd.

Phone: +852 5439-9036
E-mail: sales@odu.hk
www.odu.hk

ODU Japan K.K.

Phone: +81 3 6441 3210
E-mail: sales@odu.co.jp
www.odu.co.jp

ODU-UK Ltd.

Phone: +44 330 002 0640
E-mail: sales@odu-uk.co.uk
www.odu-uk.co.uk

ODU Denmark ApS

Phone: +45 2233 5335
E-mail: sales@odu-denmark.dk
www.odu-denmark.dk

ODU Korea Inc.

Phone: +82 2 6964 7181
E-mail: sales@odu-korea.kr
www.odu-korea.kr

ODU-USA Inc.

Phone: +1 805 484-0540
E-mail: sales@odu-usa.com
www.odu-usa.com

ODU-France SARL

Phone: +33 1 3935-4690
E-mail: sales@odu.fr
www.odu.fr

ODU Romania Manufacturing SRL

Phone: +40 269 704638
E-mail: sales@odu-romania.ro
www.odu-romania.ro

Further information and specialized representatives can be found at:

www.odu-connectors.com/contact

PRODUCTION AND LOGISTICS SITES

Germany	Otto Dunkel GmbH
China	ODU (Shanghai) Connectors Manufacturing Co., Ltd.
Mexico	ODU Mexico Manufacturing S. de R.L. de C.V.
Romania	ODU Romania Manufacturing SRL
USA	ODU North American Logistics Inc.



Simply scan the QR code to download the entire publication.

All dimensions are in mm. Some figures are for illustrative purposes only. Subject to change without notice. Errors and omissions excepted. We reserve the right to change our products and their technical specifications at any time in the interest of technical improvement. This publication supersedes all prior publications. This publication is also available as a PDF file that can be downloaded from www.odu-connectors.com

ODU CM 116 E

ODU AMC® EASY-CLEAN / C/0820 / EN